



PowerShot SX170 IS

Camera User Guide

- Make sure you read this guide, including the “Safety Precautions” (📖 13) section, before using the camera.
- Reading this guide will help you learn to use the camera properly.
- Store this guide safely so that you can use it in the future.

Switching Between Pages

Click buttons on the top of the screen.

← Contents

: return to the Contents.

← Chapter Contents

: return to the Chapter Contents page.

English

Package Contents

Before use, make sure the following items are included in the package.

If anything is missing, contact your camera retailer.



Camera



Battery Pack
NB-6LH



Battery Charger
CB-2LY/CB-2LYE



Wrist Strap



Getting Started



Warranty Card

- A memory card is not included (📖3).

Compatible Memory Cards

The following memory cards (sold separately) can be used, regardless of capacity.

- SD memory cards*
- SDHC memory cards*
- SDXC memory cards* 
- Eye-Fi cards

* Cards conforming to SD standards. However, not all memory cards have been verified to work with the camera.

About Eye-Fi Cards

This product is not guaranteed to support Eye-Fi card functions (including wireless transfer). In case of an issue with an Eye-Fi card, please check with the card manufacturer.

Also note that an approval is required to use Eye-Fi cards in many countries or regions. Without approval, use of the card is not permitted. If it is unclear whether the card has been approved for use in the area, please check with the card manufacturer.

Preliminary Notes and Legal Information





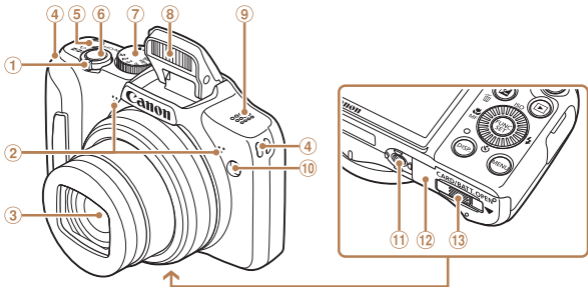

- Take and review some test shots initially to make sure the images were recorded correctly. Please note that Canon Inc., its subsidiaries and affiliates, and its distributors are not liable for any consequential damages arising from any malfunction of a camera or accessory, including memory cards, that result in the failure of an image to be recorded or to be recorded in a way that is machine readable.
- Images recorded by the camera are intended for personal use. Refrain from unauthorized recording that infringes on copyright law, and note that even for personal use, photography may contravene copyright or other legal rights at some performances or exhibitions, or in some commercial settings.
- The camera warranty is valid only in the area of purchase. In case of camera problems while abroad, return to the area of purchase before contacting a Canon Customer Support Help Desk.
- Although the LCD monitor is produced under extremely high-precision manufacturing conditions and more than 99.99% of the pixels meet design specifications, in rare cases some pixels may be defective or may appear as red or black dots. This does not indicate camera damage or affect recorded images.
- The LCD monitor may be covered with a thin plastic film for protection against scratches during shipment. If covered, remove the film before using the camera.
- When the camera is used over an extended period, it may become warm. This does not indicate damage.

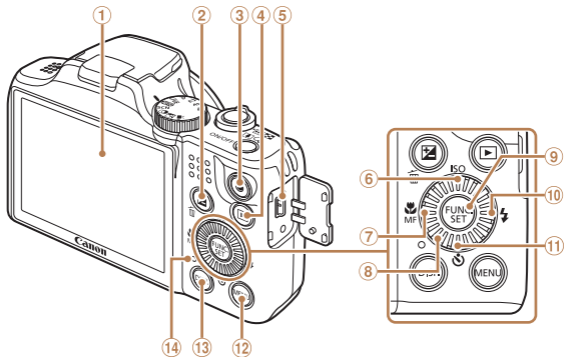
Part Names and Conventions in This Guide





- | | |
|---|---|
| <p>① Zoom lever
Shooting: < [Telephoto] > / < [Wide angle] >
Playback: < [Magnify] > / < [Index] ></p> <p>② Microphone</p> <p>③ Lens</p> <p>④ Strap mount</p> <p>⑤ Power button</p> | <p>⑥ Shutter button</p> <p>⑦ Mode dial</p> <p>⑧ Flash</p> <p>⑨ Speaker</p> <p>⑩ Lamp</p> <p>⑪ Tripod socket</p> <p>⑫ Memory card/battery cover</p> <p>⑬ DC coupler terminal cover</p> |
|---|---|

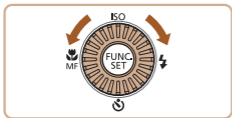

- | | |
|---|---|
| ① Screen (LCD monitor) | ⑧ Control dial |
| ② <  (Exposure compensation)> / <  (Single-image erase)> button | ⑨ FUNC./SET button |
| ③ Movie button | ⑩ <  (Flash)> / Right button |
| ④ <  (Playback)> button | ⑪ <  (Self-timer)> / Down button |
| ⑤ DIGITAL terminal | ⑫ <MENU> button |
| ⑥ <ISO (ISO speed)> / Up button | ⑬ <DISP. (Display)> button |
| ⑦ <  (Macro)> / <MF (Manual focus)> / Left button | ⑭ Indicator |



- Turning the control dial is one way to choose setting items, switch images, and perform other operations. Most of these operations are also possible with the <▲><▼><◀><▶> buttons.
- The following camera buttons and controls are represented by icons.
 - <▲> Up button ⑥ on back
 - <◀> Left button ⑦ on back
 - <▶> Right button ⑩ on back
 - <▼> Down button ⑪ on back

- In this guide, icons are used to represent the corresponding camera buttons and dials on which they appear or which they resemble.
- Shooting modes and on-screen icons and text are indicated in brackets.
- : Important information you should know
- : Notes and tips for expert camera use
- xx: Pages with related information (in this example, “xx” represents a page number)
- Instructions in this guide apply to the camera under default settings.
- For convenience, all supported memory cards are simply referred to as the “memory card”.
- The tabs shown above titles indicate whether the function is used for still images, movies, or both.

 Still Images

: Indicates that the function is used when shooting or viewing still images.

 Movies

: Indicates that the function is used when shooting or viewing movies.

Table of Contents

Package Contents	2	2 Auto Mode	49
Compatible Memory Cards	3	Shooting with Camera-Determined Settings	50
Preliminary Notes and Legal Information	4	Common, Convenient Features	59
Part Names and Conventions in This Guide	5	Image Customization Features	66
Table of Contents	9	Helpful Shooting Features ...	71
Common Camera Operations	11	Customizing Camera Operation	74
Safety Precautions	13		
<hr/>			
Basic Guide	19	3 Other Shooting Modes	78
Initial Preparations	20	Brightness / Color Customization (Live View Control)	79
Trying the Camera Out	31	Specific Scenes	80
<hr/>			
Advanced Guide	37	Special Modes for Other Purposes	82
1 Camera Basics	37	Image Effects (Creative Filters)	84
On/Off	38	Discreet Mode	91
Shutter Button	40	Shooting Movies in [P] Mode	92
Shooting Modes	41		
Shooting Display Options	42	4 P Mode	94
Using the FUNC. Menu	43	Shooting in Program AE ([P] Mode)	95
Using Menus	45		
Indicator Display	47		
Clock	48		

Image Brightness (Exposure)	96	7 Setting Menu	168
Color and Continuous Shooting	101	Adjusting Basic Camera Functions	169
Shooting Range and Focusing	107	8 Accessories	183
Flash	117	System Map	184
Other Settings	121	Optional Accessories	186
5 Tv, Av, and M Mode....	123	Using Optional Accessories.....	189
Specific Shutter Speeds ([Tv] Mode).....	124	Using the Software	193
Specific Aperture Values ([Av] Mode)	125	Printing Images	199
Specific Shutter Speeds and Aperture Values ([M] Mode).....	126	Using an Eye-Fi Card.....	216
6 Playback Mode	129	9 Appendix	219
Viewing	130	Troubleshooting	220
Browsing and Filtering Images	135	On-Screen Messages	226
Image Viewing Options	138	On-Screen Information	229
Protecting Images	143	Functions and Menu Tables.....	233
Erasing Images	149	Handling Precautions.....	255
Rotating Images.....	153	Specifications.....	256
Tagging Images as Favorites	155	Index	262
Editing Still Images	157		
Editing Movies.....	165		

Common Camera Operations

Shoot

- Use camera-determined settings (Auto Mode) 50

Shooting people well



Portraits

( 80)



Against Snow

( 81)

Matching specific scenes



Low Light

( 81)



Fireworks

( 81)

Applying special effects



Vivid Colors

( 85)



Poster Effect

( 85)



Fish-Eye Effect

( 86)



Miniature Effect

( 87)



Toy Camera Effect

( 89)



Monochrome

( 90)

- Where sound and flash are not allowed (Discreet Mode) 91
- While adjusting image settings (Live View Control) 79
- Focus on faces.....50, 80, 111
- Without using the flash (Flash Off)..... 51
- Include yourself in the shot (Self-Timer) 61, 82
- Add a date stamp..... 64

 **View**

- View images (Playback Mode)..... 130
- Automatic playback (Slideshow) 139
- On a TV 189
- On a computer 194
- Browse through images quickly 135
- Erase images 149

 **Shoot/View Movies**

- Shoot movies 50
- View movies (Playback Mode) 130

 **Print**

- Print pictures 199

 **Save**

- Save images to a computer 196

Safety Precautions

- Before using the product, please ensure that you read the safety precautions described below. Always ensure that the product is used correctly.
- The safety precautions noted on the following pages are intended to prevent injuries to yourself and other persons, or damage to the equipment.
- Be sure to also check the guides included with any separately sold accessories you use.



Warning

Denotes the possibility of serious injury or death.

- **Do not trigger the flash in close proximity to people's eyes.** Exposure to the intense light produced by the flash could damage eyesight. In particular, remain at least 1 meter (39 inches) away from infants when using the flash.

- **Store this equipment out of the reach of children and infants.**

Strap: Putting the strap around a child's neck could result in asphyxiation.

Date/time battery (if removable): Dangerous if swallowed. If this occurs, contact a doctor immediately.

- **Use only recommended power sources.**
- **Do not attempt to disassemble, alter or apply heat to the product.**
- **Avoid dropping or subjecting the product to severe impacts.**
- **To avoid the risk of injury, do not touch the interior of the product if it has been dropped or otherwise damaged.**
- **Stop using the product immediately if it emits smoke, a strange smell, or otherwise behaves abnormally.**

- **Do not use organic solvents such as alcohol, benzene, or thinner to clean the product.**
- **Do not let the product come into contact with water (e.g. sea water) or other liquids.**
- **Do not allow liquids or foreign objects to enter the camera.**

This could result in electrical shock or fire.

If liquids or foreign objects come into contact with the camera interior, immediately turn the camera off and remove the battery pack/batteries.

If the battery charger (for cameras that use one) becomes wet, unplug it from the outlet and consult your camera retailer or a Canon Customer Support Help Desk.

- **Do not look through the viewfinder (if your model has one) at bright light sources, such as the sun on a clear day.**

This could damage your eyesight.

- **Use only the recommended battery pack/batteries.**
- **Do not place the battery pack/batteries near or in direct flame.**
- **If your camera uses a battery charger, note the following precautions.**
 - **Unplug the power cord periodically, and using a dry cloth, wipe away any dust and dirt that has collected on the plug, the exterior of the power outlet, and the surrounding area.**
 - **Do not handle the power cord with wet hands.**
 - **Do not use the equipment in a manner that exceeds the rated capacity of the electrical outlet or wiring accessories. Do not use if the power cord or plug are damaged, or not fully plugged into the outlet.**
 - **Do not allow dirt or metal objects (such as pins or keys) to contact the terminals or plug.**

The battery pack/batteries may explode or leak, resulting in electrical shock or fire. This could cause injury and damage the surroundings. In the event that a battery pack leaks and the battery electrolyte contacts eyes, mouth, skin or clothing, immediately flush with water.

- **Turn the camera off in places where camera use is prohibited.**

The electromagnetic waves emitted by the camera may interfere with the operation of electronic instruments and other devices. Exercise adequate caution when using the camera in places where use of electronic devices is restricted, such as inside airplanes and medical facilities.

**Caution**

Denotes the possibility of injury.

- **When holding the camera by the strap, be careful not to bang it, subject it to strong impacts or shocks, or let it get caught on other objects.**
- **Be careful not to bump or push strongly on the lens.**

This could lead to injury or damage the camera.

- **Be careful not to subject the screen to strong impacts.**

If the screen cracks, injury may result from the broken fragments.

- **When using the flash, be careful not to cover it with your fingers or clothing.**

This could result in burns or damage to the flash.

- **Avoid using, placing or storing the product in the following places:**
 - Places subject to direct sunlight
 - Places subject to temperatures above 40 °C (104 °F)
 - Humid or dusty areas

These could cause leakage, overheating or an explosion of the battery pack/batteries, resulting in electrical shock, fire, burns or other injuries.

High temperatures may deform the product.

- **The slideshow transition effects may cause discomfort when viewed for prolonged periods.**
- **When using optional lenses, lens filters, or filter adapters (if applicable), be sure to attach these accessories firmly.**
If the lens becomes loose and falls off, it may crack, and the shards of glass may lead to cuts.
- **On cameras that raise and lower the flash automatically, make sure your finger is out of the way when the flash is lowered, to avoid pinching it.**

This could result in injury.

Caution

Denotes the possibility of damage to the equipment.

- **Do not aim the camera at bright light sources (such as the sun on a clear day).**

Doing so may damage the image sensor.

- **When using the camera on a beach or at a windy location, be careful not to allow dust or sand to enter the camera.**
- **On cameras that raise and lower the flash automatically, do not push the flash down or pry it open.**

This may cause the product to malfunction.

- **In regular use, small amounts of smoke may be emitted from the flash.**

This is due to the high intensity of the flash burning dust and foreign materials stuck to the front of the unit. Please use a cotton swab to remove dirt, dust or other foreign matter from the flash to prevent heat build-up and damage to the unit.

- **Remove and store the battery pack/batteries when you are not using the camera.**

If the battery pack or batteries are left inside the camera, damage caused by leakage may occur.

- **Before you discard the battery pack/batteries, cover the terminals with tape or other insulators.**

Contacting other metal materials may lead to fire or explosions.

- **If your camera is used with a battery charger, keep the charger unplugged when not in use. When charging the battery pack, do not leave it covered with a cloth or put other objects on it.**

Leaving the unit plugged in for a long period of time may cause it to overheat and distort, resulting in fire.

- **Do not leave the battery pack near pets.**

Pets biting the battery pack could cause leakage, overheating or explosion, resulting in fire or damage.

- **If your camera uses multiple batteries, do not use batteries that have different levels of charge together, do not use old and new batteries together, and do not insert the batteries with the + and – terminals reversed.**

This may cause the product to malfunction.

- **Do not sit down with the camera in your pocket.**

Doing so may cause malfunctions or damage the screen.

- **When putting the camera in your bag, ensure that hard objects do not come into contact with the screen. Also close the screen (so that it faces the camera body), if your camera has a screen that closes.**

- **Do not attach any hard objects to the camera.**
Doing so may cause malfunctions or damage the screen.



Basic Guide

Basic information and instructions, from initial preparations to shooting and playback

Initial Preparations20

Trying the Camera Out.....31

Initial Preparations

Prepare for shooting as follows.

Attaching the Strap

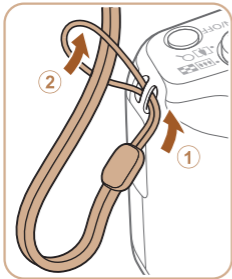

Attach the strap.

- Thread the end of the strap through the strap hole (①), and then pull the other end of the strap through the loop on the threaded end (②).
- The strap can also be attached to the left side of the camera.

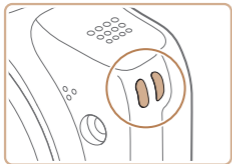

Holding the Camera



- Place the strap around your wrist.
- When shooting, keep your arms close to your body and hold the camera securely to prevent it from moving. If you have raised the flash, do not rest your fingers on it.

Charging the Battery Pack

Before use, charge the battery pack with the included charger. Be sure to charge the battery pack initially, because the camera is not sold with the battery pack charged.

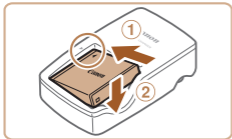

- 1 Insert the battery pack.**
 - After aligning the ▲ marks on the battery pack and charger, insert the battery pack by pushing it in (①) and down (②).

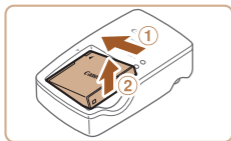
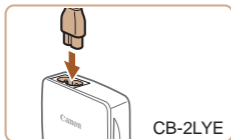
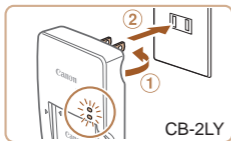

2 Charge the battery pack.

- CB-2LY: Flip out the plug (①) and plug the charger into a power outlet (②).
- CB-2LYE: Plug the power cord into the charger, then plug the other end into a power outlet.
- The charging lamp turns orange and charging begins.
- When charging is finished, the lamp turns green.

3 Remove the battery pack.

- After unplugging the battery charger, remove the battery pack by pushing it in (①) and up (②).



- To protect the battery pack and keep it in optimal condition, do not charge it continuously for more than 24 hours.
- For battery chargers that use a power cord, do not attach the charger or cord to other objects. Doing so could result in malfunction or damage to the product.



- For details on charging time and the number of shots and recording time possible with a fully charged battery pack, see “Number of Shots/Recording Time, Playback Time” (📖257).
- Charged battery packs gradually lose their charge, even when they are not used. Charge the battery pack on (or immediately before) the day of use.
- The charger can be used in areas with 100 – 240 V AC power (50/60 Hz). For power outlets in a different format, use a commercially available adapter for the plug. Never use an electrical transformer designed for traveling, which may damage the battery pack.

Inserting the Battery Pack and Memory Card

Insert the included battery pack and a memory card (sold separately).

Note that before using a new memory card (or a memory card formatted in another device), you should format the memory card with this camera (📖176).

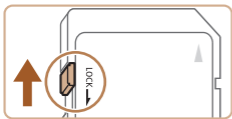

1 Check the card's write-protect tab.

- Recording is not possible on memory cards with a write-protect tab when the tab is in the locked (downward) position. Slide the tab up until it clicks into the unlocked position.

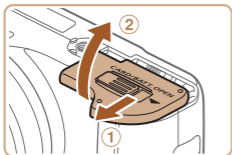

2 Open the cover.

- Slide the cover (①) and open it (②).

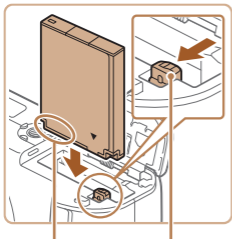

Terminals

Battery Lock

3 Insert the battery pack.

- While pressing the battery lock in the direction of the arrow, insert the battery pack as shown and push it in until it clicks into the locked position.
- If you insert the battery pack facing the wrong way, it cannot be locked into the correct position. Always confirm that the battery pack is facing the right way and locks when inserted.

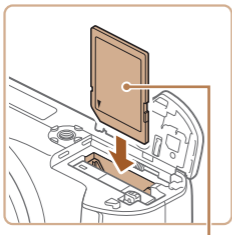

Label

4 Insert the memory card.

- Insert the memory card facing as shown until it clicks into the locked position.
- Make sure the memory card is facing the right way when you insert it. Inserting memory cards facing the wrong way may damage the camera.

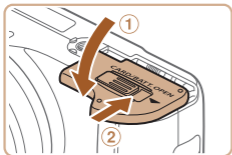

5 Close the cover.

- Lower the cover (1) and hold it down as you slide it, until it clicks into the closed position (2).



- For guidelines on how many shots or hours of recording can be saved on one memory card, see “Number of 4:3 Shots per Memory Card” (257).

Removing the Battery Pack and Memory Card

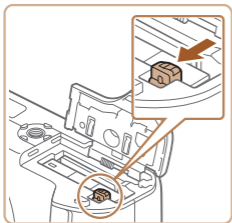

Remove the battery pack.

- Open the cover and press the battery lock in the direction of the arrow.
- The battery pack will pop up.

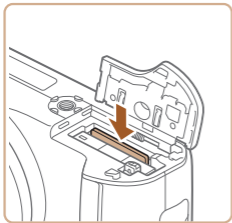

Remove the memory card.

- Push the memory card in until it clicks, and then slowly release it.
- The memory card will pop up.

Setting the Date and Time

Set the current date and time correctly as follows if the [Date/Time] screen is displayed when you turn the camera on. Information you specify this way is recorded in image properties when you shoot, and it is used when you manage images by shooting date or print images showing the date.

You can also add a date stamp to shots, if you wish (📖64).



1 Turn the camera on.

- Press the power button.
- The [Date/Time] screen is displayed.

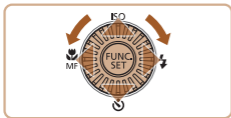
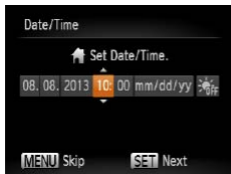

2 Set the date and time.

- Press the <◀>> buttons to choose an option.
- Press the <▲>><▼> buttons or turn the <FUNC SET> dial to specify the date and time.
- When finished, press the <FUNC SET> button.

3 Set the home time zone.

- Press the <◀>> buttons or turn the <FUNC SET> dial to choose your home time zone.

4 Finish the setup process.

- Press the <FUNC SET> button when finished. After a confirmation message, the setting screen is no longer displayed.
- To turn off the camera, press the power button.



- Unless you set the date, time, and home time zone, the [Date/Time] screen will be displayed each time you turn the camera on. Specify the correct information.



- To set daylight saving time (1 hour ahead), choose [☀️ Off] in step 2 and then choose [☀️] by pressing the <▲><▼> buttons or turning the <⚙️> dial.

■ Changing the Date and Time

Adjust the date and time as follows.



1 Access the camera menu.

- Press the <MENU> button.

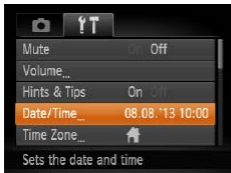

2 Choose [Date/Time].

- Move the zoom lever to choose the [YT] tab.
- Press the <▲><▼> buttons or turn the <⚙️> dial to choose [Date/Time], and then press the <FUNC SET> button.

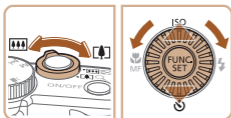

3 Change the date and time.

- Follow step 2 in “Setting the Date and Time” (📖27) to adjust the settings.
- Press the <MENU> button to close the menu.



- Date/time settings can be retained for about 3 weeks by the camera's built-in date/time battery (backup battery) after the battery pack is removed.
- The date/time battery will be charged in about 4 hours once you insert a charged battery pack or connect the camera to an AC adapter kit (sold separately, [📖186](#)), even if the camera is left off.
- Once the date/time battery is depleted, the [Date/Time] screen will be displayed when you turn the camera on. Set the correct date and time as described in “Setting the Date and Time” ([📖26](#)).

Display Language

Change the display language as needed.



1 Enter Playback mode.

- Press the <▶> button.

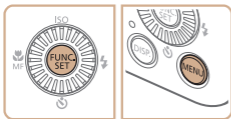

2 Access the setting screen.

- Press and hold the <FUNC SET> button, and then immediately press the <MENU> button.

English	Suomi	Magyar
Deutsch	Norsk	Türkçe
Français	Svenska	繁體中文
Nederlands	Español	한국어
Dansk	简体中文	العربية
Italiano	Русский	الرومانية
Українська	Português	Română
B. Malaysia	Ελληνικά	فارسی
Indonesian	Polski	हिन्दी
Tiếng Việt	Čeština	日本語

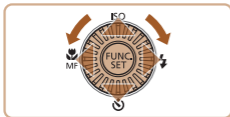

3 Set the display language.

- Press the <▲><▼><◀><▶> buttons or turn the <⊙> dial to choose a language, and then press the <FUNC SET> button.
- Once the display language has been set, the setting screen is no longer displayed.



- The current time is displayed if you wait too long in step 2 after pressing the <FUNC SET> button before you press the <MENU> button. In this case, press the <FUNC SET> button to dismiss the time display and repeat step 2.
- You can also change the display language by pressing the <MENU> button and choosing [Language] on the [F1] tab.

Trying the Camera Out

Follow these instructions to turn the camera on, shoot still images or movies, and then view them.

Shooting (Smart Auto)

For fully automatic selection of the optimal settings for specific scenes, simply let the camera determine the subject and shooting conditions.



1 Turn the camera on.

- Press the power button.
- The startup screen is displayed.



2 Enter [AUTO] mode.

- Set the mode dial to [AUTO].
- Aim the camera at the subject. The camera will make a slight clicking noise as it determines the scene.
- Icons representing the scene and image stabilization mode are displayed in the upper right of the screen.
- Frames displayed around any detected subjects indicate that they are in focus.



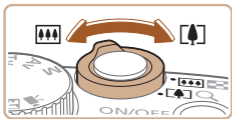

3 Compose the shot.

- To zoom in and enlarge the subject, move the zoom lever toward <[📷]> (telephoto), and to zoom away from the subject, move it toward <[📷]> (wide angle).

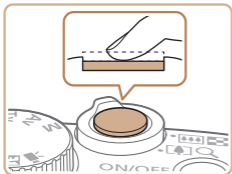

4 Shoot. Shooting Still Images

① Focus.

- Press the shutter button lightly, halfway down. The camera beeps twice after focusing, and AF frames are displayed to indicate image areas in focus.
- If [Raise the flash] is displayed, lift the flash with your finger to prepare it for use. If you prefer not to use the flash, push it down with your finger, into the camera.

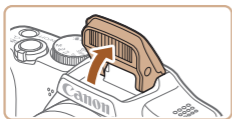
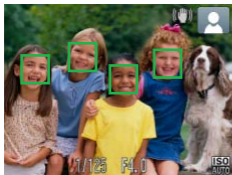

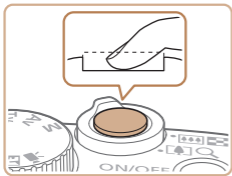

② Shoot.

- Press the shutter button all the way down.
- As the camera shoots, a shutter sound is played, and in low-light conditions when you have raised the flash, it fires automatically.
- Keep the camera still until the shutter sound ends.
- After displaying your shot, the camera will revert to the shooting screen.

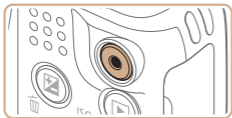

Shooting Movies

① Start shooting.

- Press the movie button. The camera beeps once as recording begins, and [●Rec] is displayed with the elapsed time.
- Black bars displayed on the top and bottom edges of the screen indicate image areas not recorded.
- Frames displayed around any detected faces indicate that they are in focus.
- Once recording begins, take your finger off the movie button.

Elapsed Time



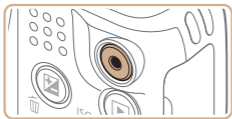

② Finish shooting.

- Press the movie button again to stop shooting. The camera beeps twice as recording stops.

Viewing

After shooting images or movies, you can view them on the screen as follows.



1 Enter Playback mode.

- Press the <▶> button.
- Your last shot is displayed.

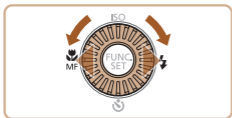



2 Browse through your images.

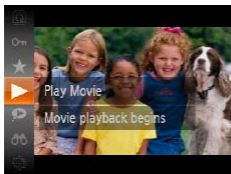

- To view the previous image, press the <◀> button or turn the <◉> dial counterclockwise. To view the next image, press the <▶> button or turn the <◉> dial clockwise.
- Press and hold the <◀><▶> buttons to browse through images quickly. Images appear grainy at this time.





- To access Scroll Display mode, turn the  dial rapidly. In this mode, turn the  dial to browse through images.
- To return to single-image display, press the  button.
- Movies are identified by a [SET ▶] icon. To play movies, go to step 3.

3 Play movies.

- Press the  button, choose [▶] (either press the <▲><▼> buttons or turn the  dial), and then press the  button again.
- Playback now begins, and after the movie is finished, [SET ▶] is displayed.
- To adjust the volume, press the <▲><▼> buttons.



- To switch to Shooting mode from Playback mode, press the shutter button halfway.

Erasing the Images

You can choose and erase unneeded images one by one. Be careful when erasing images, because they cannot be recovered.

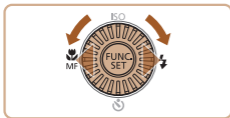

1 Choose an image to erase.

- Press the <◀>>▶> buttons or turn the <⦿> dial to choose an image.

2 Erase the image.

- Press the <🗑️> button.
- After [Erase?] is displayed, press the <◀>>▶> buttons or turn the <⦿> dial to choose [Erase], and then press the <FUNC SET> button.
- The current image is now erased.
- To cancel erasure, press the <◀>>▶> buttons or turn the <⦿> dial to choose [Cancel], and then press the <FUNC SET> button.



- You can also erase all images at once (📖150).

Advanced Guide

1

Camera Basics

Practical guide that introduces other camera basics and describes shooting and playback options

On/Off	38	Using the FUNC. Menu.....	43
Shutter Button	40	Using Menus	45
Shooting Modes.....	41	Indicator Display.....	47
Shooting Display Options.....	42	Clock.....	48

On/Off



Shooting Mode

- Press the power button to turn the camera on and prepare for shooting.
- To turn the camera off, press the power button again.



Playback Mode

- Press the <▶> button to turn the camera on and view your shots.
- To turn the camera off, press the <▶> button again.



- To switch to Playback mode from Shooting mode, press the <▶> button.
- To switch to Shooting mode from Playback mode, press the shutter button halfway (📖 40).
- The lens will be retracted after about one minute once the camera is in Playback mode. You can turn the camera off when the lens is retracted by pressing the <▶> button.

Power-Saving Features (Auto Power Down)

As a way to conserve battery power, the camera automatically deactivates the screen (Display Off) and then turns itself off after a specific period of inactivity.



Power Saving in Shooting Mode

The screen is automatically deactivated after about one minute of inactivity. In about two more minutes, the lens is retracted and the camera turns itself off. To activate the screen and prepare for shooting when the screen is off but the lens is still out, press the shutter button halfway (40).

Power Saving in Playback Mode

The camera turns itself off automatically after about five minutes of inactivity.



- You can deactivate Auto Power Down and adjust the timing of Display Off, if you prefer (174).
- Power saving is not active while the camera is connected to a computer (196).

Shutter Button

To ensure your shots are in focus, always begin by holding the shutter button halfway down, and once the subject is in focus, press the button all the way down to shoot.

In this manual, shutter button operations are described as pressing the button *halfway* or *all the way down*.

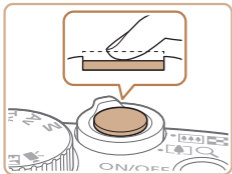

1 Press halfway. (Press lightly to focus.)

- Press the shutter button halfway. The camera beeps twice, and AF frames are displayed around image areas in focus.

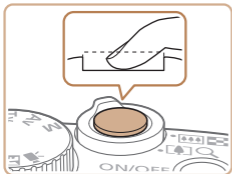

2 Press all the way down. (From the halfway position, press fully to shoot.)

- The camera shoots, as a shutter sound is played.
- Keep the camera still until the shutter sound ends.



- Images may be out of focus if you shoot without initially pressing the shutter button halfway.
- Length of shutter sound playback varies depending on the time required for the shot. It may take longer in some shooting scenes, and images will be blurry if you move the camera (or the subject moves) before the shutter sound ends.

Shooting Modes

Use the mode dial to access each shooting mode.

Live View Control Mode

Customize image brightness or colors when shooting (📖79).

Auto Mode

Fully automatic shooting, with camera-determined settings (📖31, 50).

Special Scene Mode

Shoot with optimal settings for specific scenes (📖80).

Creative Filters Mode

Add a variety of effects to images when shooting (📖84).

P, Tv, Av, and M Modes

Take a variety of shots using your preferred settings (📖94, 123).

Movie Mode

For shooting movies (📖92).
You can also shoot movies when the mode dial is not set to Movie mode, simply by pressing the movie button.

Discreet Mode

Shoot without the flash or camera sounds (📖91).



- You can turn the mode dial to switch to Shooting mode from Playback mode.

Shooting Display Options

Press the <DISP.> button to view other information on the screen, or to hide the information. For details on the information displayed, see “On-Screen Information” (📖229).



Information is displayed



No information is displayed



- Screen brightness is automatically increased by the night display function when you are shooting under low light, making it easier to check how shots are composed. However, on-screen image brightness may not match the brightness of your shots. Note that any on-screen image distortion or jerky subject motion will not affect recorded images.
- For playback display options, see “Switching Display Modes” (📖133).

Using the FUNC. Menu

Configure commonly used functions through the FUNC. menu as follows.

Note that menu items and options vary depending on the shooting mode (📖239 – 242) or playback mode (📖254).



1 Access the FUNC. menu.

- Press the <FUNC. SET> button.



Options

Menu Items

2 Choose a menu item.

- Press the <▲><▼> buttons or turn the <◉> dial to choose a menu item, and then press the <FUNC. SET> or <▶> button.
- Depending on the menu item, functions can be specified simply by pressing the <FUNC. SET> or <▶> button, or another screen is displayed for configuring the function.



3 Choose an option.

- Press the <▲><▼> buttons or turn the <◉> dial to choose an option.
- To return to the menu items, press the <◀> button.



4 Finish the setup process.

- Press the <FUNC. SET> button.
- The screen before you pressed the <FUNC. SET> button in step 1 is displayed again, showing the option you configured.



- To undo any accidental setting changes, you can restore the camera's default settings ( 182).

Using Menus

Configure a variety of camera functions through other menus as follows. Menu items are grouped by purpose on tabs, such as shooting [📷], playback [▶], and so on. Note that available menu items vary depending on the selected shooting or playback mode (📖245 – 254).



1 Access the menu.

- Press the <MENU> button.

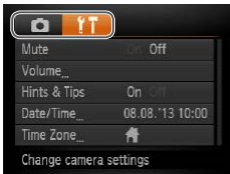

2 Choose a tab.

- Move the zoom lever to choose a tab.
- After you have pressed the <▲><▼> buttons to choose a tab initially, you can switch between tabs by pressing the <◀><▶> buttons.

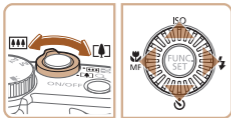

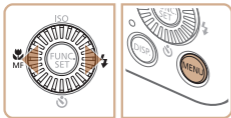
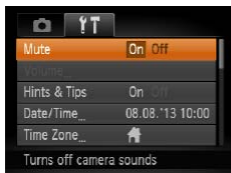

3 Choose a menu item.

- Press the <▲><▼> buttons or turn the <⊙> dial to choose a menu item.
- For menu items with options not shown, first press the <FUNC. SET> or <▶> button to switch screens, and then either press the <▲><▼> buttons or turn the <⊙> dial to select the menu item.
- To return to the previous screen, press the <MENU> button.

4 Choose an option.

- Press the <◀><▶> buttons to choose an option.

5 Finish the setup process.



- Press the <MENU> button to return to the screen displayed before you pressed the <MENU> button in step 1.



- To undo any accidental setting changes, you can restore the camera's default settings (📖182).

Indicator Display

The indicator on the back of the camera (6) lights up or blinks depending on the camera status.

Color	Indicator Status	Camera Status
Green	On	Connected to a computer ( 196), or display off ( 39, 174)
	Blinking	Starting up, recording/reading/transmitting images, or shooting long exposures ( 124, 126)





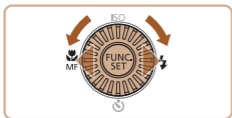
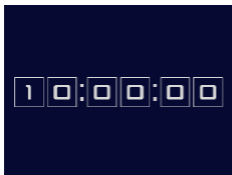

- When the indicator blinks green, never turn the camera off, open the memory card/battery cover, or shake or jolt the camera, which may corrupt images or damage the camera or memory card.

Clock

You can check the current time.



- Press and hold the  button.
- The current time appears.
- If you hold the camera vertically while using the clock function, it will switch to vertical display. Press the   buttons or turn the  dial to change the display color.
- Press the  button again to cancel the clock display.



- When the camera is off, press and hold the  button, then press the power button to display the clock.

2

Auto Mode

Convenient mode for easy shots with greater control over shooting

Shooting with Camera-Determined Settings	50	Helpful Shooting	
Common, Convenient		Features	71
Features	59	Customizing Camera	
Image Customization		Operation	74
Features	66		

Shooting with Camera-Determined Settings

For fully automatic selection of the optimal settings for specific scenes, simply let the camera determine the subject and shooting conditions.

Still Images

Movies

Shooting (Smart Auto)



1 Turn the camera on.

- Press the power button.
- The startup screen is displayed.

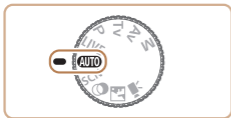

2 Enter [AUTO] mode.

- Set the mode dial to [AUTO].
- Aim the camera at the subject. The camera will make a slight clicking noise as it determines the scene.
- Icons representing the scene and image stabilization mode are displayed in the upper right of the screen (📖56).
- Frames displayed around any detected subjects indicate that they are in focus.



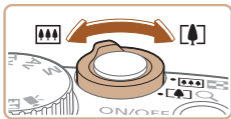

Zoom Bar



Focus Range (approx.)

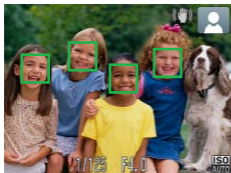
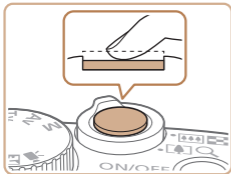

3 Compose the shot.

- To zoom in and enlarge the subject, move the zoom lever toward <[Telephoto icon]> (telephoto), and to zoom away from the subject, move it toward <[Wide angle icon]> (wide angle). (A zoom bar showing the zoom position is displayed.)

4 Shoot. Shooting Still Images

① Focus.

- Press the shutter button halfway. The camera beeps twice after focusing, and AF frames are displayed to indicate image areas in focus.
- Several AF frames are displayed when multiple areas are in focus.
- If [Raise the flash] is displayed, lift the flash with your finger to prepare it for use. If you prefer not to use the flash, push it down with your finger, into the camera.

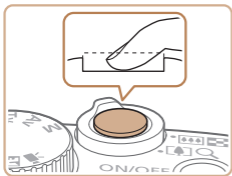

② Shoot.

- Press the shutter button all the way down.
- As the camera shoots, a shutter sound is played, and in low-light conditions when you have raised the flash, it fires automatically.
- Keep the camera still until the shutter sound ends.
- After displaying your shot, the camera will revert to the shooting screen.

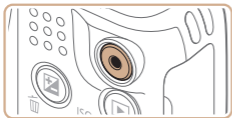

Shooting Movies

① Start shooting.

- Press the movie button.
The camera beeps once as recording begins, and [●Rec] is displayed with the elapsed time.
- Black bars displayed on the top and bottom edges of the screen indicate image areas not recorded.
- Frames displayed around any detected faces indicate that they are in focus.
- Once recording begins, take your finger off the movie button.

Elapsed Time





② Resize the subject and recompose the shot as needed.

- To resize the subject, repeat the operations in step 3 (📖51). However, note that the sound of camera operations will be recorded, and movies shot at zoom factors shown in blue will look grainy.
- When you recompose shots, the focus, brightness, and colors will be automatically adjusted.

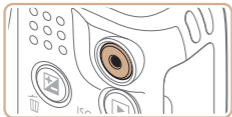

③ Finish shooting.

- Press the movie button again to stop shooting. The camera beeps twice as recording stops.
- Recording will stop automatically when the memory card becomes full.

■ Still Images/Movies



- If the camera is turned on while the <DISP.> button is held down, the camera will no longer sound. To activate sounds again, press the <MENU> button and choose [Mute] on the [YT] tab, and then press the <◀> buttons to choose [Off].

Still Images



- A blinking [📷] icon warns that images are more likely to be blurred by camera shake. In this case, mount the camera on a tripod or take other measures to keep it still.
 - If your shots are dark despite the flash firing, move closer to the subject. For details on the flash range, see “Flash Range” (📖258).
 - The subject may be too close if the camera only beeps once when you press the shutter button halfway. For details on the focusing range (shooting range), see “Shooting Range” (📖259).
 - To reduce red-eye and to assist in focusing, the lamp may be activated when shooting in low-light conditions.
 - A blinking [⚡] icon displayed when you attempt to shoot indicates that shooting is not possible until the flash has finished recharging. Shooting can resume as soon as the flash is ready, so either press the shutter button all the way down and wait, or release it and press it again.
 - Although you can shoot again before the shooting screen is displayed, your previous shot may determine the focus, brightness, and colors used.
-



- You can change how long images are displayed after shots (📖76).

Movies



- Keep your fingers away from the microphone while shooting movies. Blocking the microphone may prevent audio from being recorded or may cause the recording to sound muffled.
- Avoid touching camera controls other than the movie button when shooting movies, because sounds made by the camera will be recorded.



- Audio is recorded in stereo.

Scene Icons

In **[AUTO]** mode, shooting scenes determined by the camera are indicated by the icon displayed, and corresponding settings are automatically selected for optimal focusing, subject brightness, and color.

Subject Background	People			Other Subjects			Icon Background Color
	In Motion*1	Shadows on Face*1	In Motion*1	At Close Range			
Bright							Gray
Backlit			—				
With Blue Sky							Light Blue
Backlit			—				
Sunsets	—				—		Orange
Spotlights							Dark Blue
Dark							
Tripod Used		—			—		

*1 Not displayed for movies.







*2 Displayed in dark scenes when the camera is held still, as when mounted on a tripod.



- Try shooting in **[P]** mode (📖 94) if the scene icon does not match actual shooting conditions, or if it is not possible to shoot with your expected effect, color, or brightness.

Image Stabilization Icons

Optimal image stabilization for the shooting conditions is automatically applied (Intelligent IS). Additionally, the following icons are displayed in **[AUTO]** mode.

	<p>Image stabilization for still images</p>		<p>Image stabilization for movies, reducing strong camera shake, as when shooting while walking (Dynamic IS)</p>
	<p>Image stabilization for still images when panning*</p>		<p>Image stabilization for slow camera shake, such as when shooting movies at telephoto (Powered IS)</p>
	<p>Image stabilization for macro shots (Hybrid IS)</p>		<p>No image stabilization, because the camera is mounted on a tripod or held still by other means</p>

* Displayed when you pan, following moving subjects with the camera. When you follow subjects moving horizontally, image stabilization only counteracts vertical camera shake, and horizontal stabilization stops. Similarly, when you follow subjects moving vertically, image stabilization only counteracts horizontal camera shake.



- To cancel image stabilization, set [IS Mode] to [Off] (📖 122). In this case, an IS icon is not displayed.

On-Screen Frames

A variety of frames are displayed once the camera detects subjects you are aiming the camera at.

- A white frame is displayed around the subject (or person's face) determined by the camera to be the main subject, and gray frames are displayed around other detected faces. Frames follow moving subjects within a certain range to keep them in focus.

However, if the camera detects subject movement, only the white frame will remain on the screen.

- When you are pressing the shutter button halfway and the camera detects subject movement, a blue frame is displayed, and the focus and image brightness are constantly adjusted (Servo AF).



- Try shooting in **[P]** mode ( 94) if no frames are displayed, if frames are not displayed around desired subjects, or if frames are displayed on the background or similar areas.

Common, Convenient Features

Still Images

Movies

Zooming In Closer on Subjects (Digital Zoom)

When distant subjects are too far away to enlarge using the optical zoom, use digital zoom for up to about 64x enlargement.



1 Move the zoom lever toward .

- Hold the lever until zooming stops.
- Zooming stops at the largest possible zoom factor (before the image becomes noticeably grainy), which is then indicated on the screen.

2 Move the zoom lever toward again.

- The camera zooms in even closer on the subject.

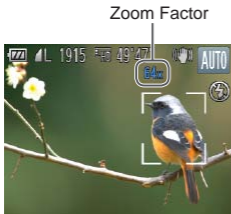



- Moving the zoom lever will display the zoom bar (which indicates the zoom position). The color of the zoom bar will change depending on the zoom range.
 - White range: optical zoom range where the image will not appear grainy.
 - Yellow range: digital zoom range where the image is not noticeably grainy (ZoomPlus).
 - Blue range: digital zoom range where the image will appear grainy.

Because the blue range will not be available at some resolution settings (67), the maximum zoom factor can be achieved by following step 1.

- Zoomed images may look grainy under some resolution settings (67) and zoom factors. In this case, the zoom factor is shown in blue.



- Focal length when optical and digital zoom are combined is as follows (35mm film equivalent).
28 – 1792 mm (28 – 448 mm with optical zoom alone)
- To deactivate digital zoom, press the <MENU> button, choose [Digital Zoom] on the  tab, and then choose [Off].

Using the Self-Timer

With the self-timer, you can include yourself in group photos or other timed shots. The camera will shoot about 10 seconds after you press the shutter button.



1 Configure the setting.

- Press the <▼> button, choose [10] (either press the <▲><▼> buttons or turn the <⊙> dial), and then press the <FUNC SET> button.
- Once the setting is complete, [10] is displayed.

2 Shoot.

- For Still Images: Press the shutter button halfway to focus on the subject, and then press it all the way down.
- For Movies: Press the movie button.



- Once you start the self-timer, the lamp will blink and the camera will play a self-timer sound.
- Two seconds before the shot, the blinking and sound will speed up. (The lamp will remain lit in case the flash fires.)
- To cancel shooting after you have triggered the self-timer, press the <MENU> button.
- To restore the original setting, choose [OFF] in step 1.

Still Images

Movies

Using the Self-Timer to Avoid Camera Shake

This option delays shutter release until about two seconds after you have pressed the shutter button. If the camera is unsteady while you are pressing the shutter button, it will not affect your shot.

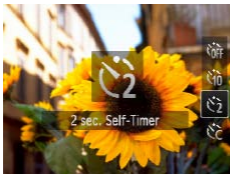

- Follow step 1 in “Using the Self-Timer” (📖61) and choose [2].
- Once the setting is complete, [2] is displayed.
- Follow step 2 in “Using the Self-Timer” (📖61) to shoot.

■ Customizing the Self-Timer

You can specify the delay (0 – 30 seconds) and number of shots (1 – 10).

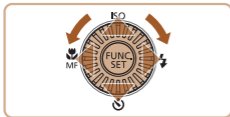
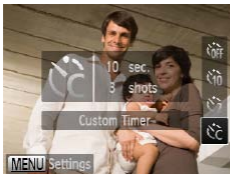

1 Choose [CC].

- Following step 1 in “Using the Self-Timer” (📖61), choose [CC] and press the <MENU> button immediately.

2 Configure the setting.

- Press the <▲><▼> buttons to choose [Delay] or [Shots].
- Press the <◀><▶> buttons or turn the <⚙️> dial to choose a value, and then press the <FUNC. SET> button.
- Once the setting is complete, [CC] is displayed.
- Follow step 2 in “Using the Self-Timer” (📖61) to shoot.



- For movies shot using the self-timer, [Delay] represents the delay before recording begins, but the [Shots] setting has no effect.



- When you specify multiple shots, image brightness and white balance are determined by the first shot. More time is required between shots when the flash fires or when you have specified to take many shots. Shooting will stop automatically when the memory card becomes full.
- When a delay longer than two seconds is specified, two seconds before the shot, the lamp blinking and self-timer sound will speed up. (The lamp will remain lit in case the flash fires.)

Adding a Date Stamp

The camera can add the shooting date to images, in the lower-right corner.

However, note that date stamps cannot be edited or removed, so confirm beforehand that the date and time are correct (📖26).

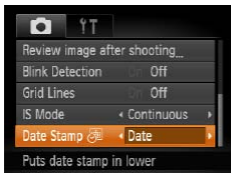

1 Configure the setting.

- Press the <MENU> button, choose [Date Stamp 📅] on the [📷] tab, and then choose the desired option (📖45).
- Once the setting is complete, [📅] is displayed.



2 Shoot.

- As you take shots, the camera adds the shooting date or time to the lower-right corner of images.
- To restore the original setting, choose [Off] in step 1.



- Date stamps cannot be edited or removed.





- Shots taken without adding a date stamp can be printed with one as follows.
However, adding a date stamp this way to images that already have one may cause it to be printed twice.
 - Print using printer functions ( 199)
 - Use camera DPOF print settings ( 207) to print
 - Use the software downloaded from the Canon website to print ( 193)

Image Customization Features

Still Images

Changing the Aspect Ratio

Change the image aspect ratio (ratio of width to height) as follows.

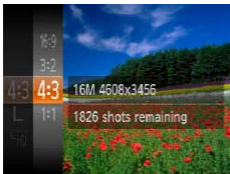



- Press the <FUNC SET> button, choose [4:3] in the menu, and choose the desired option (📖43).
- Once the setting is complete, the screen aspect ratio will be updated.
- To restore the original setting, repeat this process but choose [4:3].

16:9	Same aspect ratio as widescreen HDTVs.
3:2	Same aspect ratio as 35mm film, used for printing images at 5 x 7-inch or postcard sizes.
4:3	Native aspect ratio of the camera screen, also used for display on standard-definition televisions or similar display devices, or for printing images at 3.5 x 5-inch or A-series sizes.
1:1	Square aspect ratio.

Changing Image Resolution (Size)

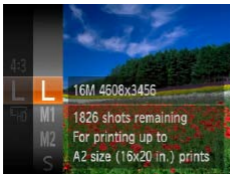
Choose from 4 levels of image resolution, as follows. For guidelines on how many shots at each resolution setting can fit on a memory card, see “Number of 4:3 Shots per Memory Card” (257).



- Press the  button, choose [L] in the menu, and choose the desired option (43).
- The option you configured is now displayed.
- To restore the original setting, repeat this process but choose [L].

Guidelines for Choosing Resolution Based on Paper Size (for 4:3 Images)

A2 (16.5 x 23.4 in.)	L
A3 – A5 (11.7 x 16.5 – 5.8 x 8.3 in.)	
5 x 7 in. Postcard 3.5 x 5 in.	

- [S]: For e-mailing images.

Red-Eye Correction

Red-eye that occurs in flash photography can be automatically corrected as follows.

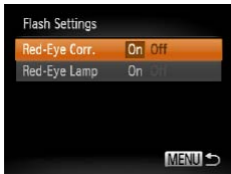

1 Access the [Flash Settings] screen.

- Press the <MENU> button, choose [Flash Settings] on the [📷] tab, and then press the <FUNC SET> button (📖45).

2 Configure the setting.

- Choose [Red-Eye Corr.], and then choose [On] (📖46).
- Once the setting is complete, [👁] is displayed.
- To restore the original setting, repeat this process but choose [Off].



- Red-eye correction may be applied to image areas other than eyes (if the camera misinterprets red eye makeup as red pupils, for example).



- You can also correct existing images (📖163).
- You can also access the screen in step 2 when the flash is up by pressing the <▶> button and immediately pressing the <MENU> button.

Movies

Changing Movie Image Quality

2 image quality settings are available. For guidelines on the maximum movie length at each level of image quality that will fit on a memory card, see “Recording Time per Memory Card” (📖258).

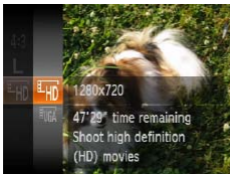

- Press the <FUNC SET> button, choose [HD] in the menu, and choose the desired option (📖43).
- The option you configured is now displayed.
- To restore the original setting, repeat this process but choose [VGA].

Image Quality	Resolution	Frame Rate	Details
[HD]	1280 x 720	25 fps	For shooting in HD
[VGA]	640 x 480	30 fps	For shooting in standard definition



- In [HD] mode, black bars displayed on the top and bottom edges of the screen indicate image areas not recorded.

Using the Wind Filter

Distorted audio caused by recording when the wind is strong can be reduced. However, the recording may sound unnatural when this option is used when there is no wind.

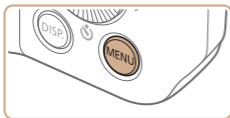

- Press the <MENU> button, choose [Wind Filter] on the [Camera] tab, and then choose [On] (45).
- To restore the original setting, repeat this process but choose [Off].

Helpful Shooting Features

Still Images

Movies

Displaying Grid Lines

Grid lines can be displayed on the screen for vertical and horizontal reference while shooting.

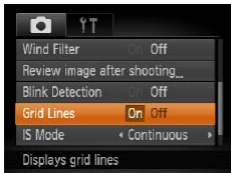
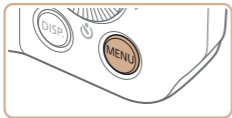

- Press the <MENU> button, choose [Grid Lines] on the [📷] tab, and then choose [On] (📖45).
- Once the setting is complete, grid lines are displayed on the screen.
- To restore the original setting, repeat this process but choose [Off].



- Grid lines are not recorded in your shots.

Magnifying the Area in Focus

You can check the focus by pressing the shutter button halfway, which will enlarge the portion of the image in focus in the AF frame.

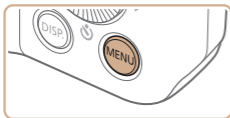

1 Configure the setting.

- Press the <MENU> button, choose [AF-Point Zoom] on the [📷] tab, and then choose [On] (📖45).

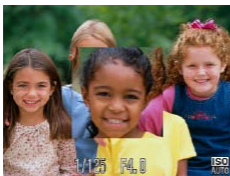

2 Check the focus.

- Press the shutter button halfway. The face detected as the main subject is now magnified.
- To restore the original setting, choose [Off] in step 1.



- The area in focus will not be magnified when you press the shutter button halfway if a face was not detected, if the person is too close to the camera and their face is too large for the screen, or if the camera detects subject movement.



- The display will not magnify when using the digital zoom (📖59) or Tracking AF (📖112).

Still Images

Checking for Closed Eyes

[👁] is displayed when the camera detects that people may have closed their eyes.

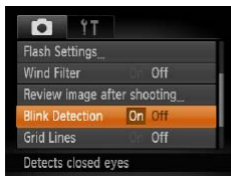
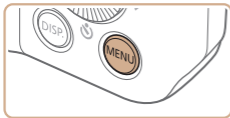

1 Configure the setting.

- Press the <MENU> button, choose [Blink Detection] on the [📷] tab, and then choose [On] (📖45).

2 Shoot.

- [👁] flashes when the camera detects a person whose eyes are closed.
- To restore the original setting, choose [Off] in step 1.



- When you have specified multiple shots in [📷] mode, this function is only available for the final shot.
- A frame is displayed around people whose eyes are closed when you have selected [2 sec.], [4 sec.], [8 sec.], or [Hold] in [Display Time] (📖76).

Customizing Camera Operation

Customize shooting functions on the MENU [📷] tab as follows. For instructions on menu functions, see “Using Menus” (📖45).

Still Images

Deactivating the AF-Assist Beam

You can deactivate the lamp that normally lights up to help you focus when you press the shutter button halfway in low-light conditions.



- Press the <MENU> button, choose [AF-assist Beam] on the [📷] tab, and then choose [Off] (📖45).
- To restore the original setting, repeat this process but choose [On].

Deactivating the Red-Eye Reduction Lamp

You can deactivate the red-eye reduction lamp that lights up to reduce red-eye when the flash is used in low-light shots.

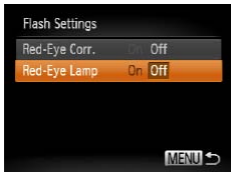

1 Access the [Flash Settings] screen.

- Press the <MENU> button, choose [Flash Settings] on the [📷] tab, and then press the <FUNC SET> button (📖 45).

2 Configure the setting.

- Choose [Red-Eye Lamp], and then choose [Off] (📖 46).
- To restore the original setting, repeat this process but choose [On].

Changing the Image Display Style after Shots

You can change how long images are displayed and what information is displayed immediately after shooting.

Changing the Image Display Period after Shots

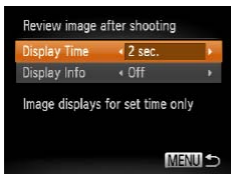

1 Access the [Review image after shooting] screen.

- Press the <MENU> button, choose [Review image after shooting] on the [CAMERA] tab, and then press the <FUNC-SET> button (45).

2 Configure the setting.

- Press the <▲><▼> buttons or turn the <DISP.> dial to choose [Display Time]. Press the <◀><▶> buttons to choose the desired option.
- To restore the original setting, repeat this process but choose [Quick].

Quick	Displays images only until you can shoot again.
2 sec., 4 sec., 8 sec.	Displays images for the specified time. Even while the shot is displayed, you can take another shot by pressing the shutter button halfway again.
Hold	Displays images until you press the shutter button halfway.
Off	No image display after shots.

Changing the Screen Displayed after Shots

Change the way images are displayed after shots as follows.

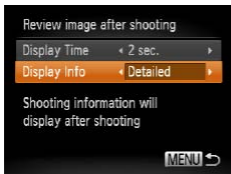

1 Set [Display Time] to [2 sec.], [4 sec.], [8 sec.], or [Hold] (📖76).

2 Configure the setting.

- Press the <▲><▼> buttons or turn the <🔘> dial to choose [Display Info]. Press the <◀><▶> buttons to choose the desired option.
- To restore the original setting, repeat this process but choose [Off].

Off	Displays only the image.
Detailed	Displays shooting details (📖231).



- When [Display Time] (📖76) is set to [Off] or [Quick], [Display Info] is set to [Off] and cannot be changed.
- By pressing the <DISP.> button while an image is displayed after shooting, you can switch the display information. Note that the settings of [Display Info] on the [📷] tab are not changed. You can also erase images by pressing the <🗑️> button, or protect (📖143) or tag images as favorites (📖155) by pressing the <FUNC SET> button.

3

Other Shooting Modes

Shoot more effectively in various scenes, and take shots enhanced with unique image effects or captured using special functions

Brightness / Color Customization (Live View Control).....	79
Specific Scenes	80
Special Modes for Other Purposes.....	82
Image Effects (Creative Filters)	84
Discreet Mode	91
Shooting Movies in [P] Mode.....	92

Brightness / Color Customization (Live View Control)

Image brightness or colors when shooting can be easily customized as follows.





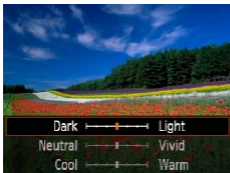

1 Enter [LIVE] mode.

- Set the mode dial to [LIVE].



2 Configure the setting.

- Press the  button to access the setting screen. Press the  buttons to choose a setting item, and then press the  buttons or turn the  dial to adjust the value as you watch the screen.
- Press the  button.

3 Shoot.

Brightness	For brighter images, adjust the level to the right, and for darker images, adjust it to the left.
Color	For more vivid images, adjust the level to the right, and for more subdued images, adjust it to the left.
Tone	For a warm, reddish tone, adjust the level to the right, and for a cool, bluish tone, adjust it to the left.

Specific Scenes

Choose a mode matching the shooting scene, and the camera will automatically configure the settings for optimal shots.



- 1 Enter [SCN] mode.**
 - Set the mode dial to [SCN].

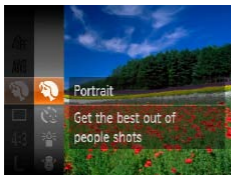

- 2 Choose a shooting mode.**
 - Press the <FUNC SET> button, choose [👤] in the menu, and then choose a shooting mode (📖43).

- 3 Shoot.**

Still Images

Movies



- 👤 **Shoot portraits (Portrait)**
 - Take shots of people with a softening effect.



Still Images

Shoot under low light (Low Light)

- Shoot with minimal camera shake and subject blur even in low-light conditions.



Still Images

Movies

Shoot with snowy backgrounds (Snow)

- Bright, natural-colored shots of people against snowy backgrounds.





Still Images

Movies



Shoot fireworks (Fireworks)

- Vivid shots of fireworks.



- In  mode, mount the camera on a tripod or take other measures to keep it still and prevent camera shake. Additionally, you should set [IS Mode] to [Off] when using a tripod or other means to secure the camera ( 122).



-  mode resolution is [M] (2304 x 1728) and cannot be changed.
- In  mode, although no frames are displayed when you press the shutter button halfway, optimal focus is still determined.

Special Modes for Other Purposes

Still Images

Using the Face Self-Timer

The camera will shoot about two seconds after detecting that the face of another person (such as the photographer) has entered the shooting area (📖111). This is useful when including yourself in group photos or similar shots.



1 Choose [👤].

- Follow steps 1 – 2 in “Specific Scenes” (📖80) and choose [👤].

2 Compose the shot and press the shutter button halfway.

- Make sure a green frame is displayed around the face you focus on and white frames around other faces.

3 Press the shutter button all the way down.

- The camera now enters shooting standby mode, and [Look straight at camera to start count down] is displayed.
- The lamp blinks and the self-timer sound is played.



4 Join the subjects in the shooting area and look at the camera.

- After the camera detects a new face, the lamp blinking and self-timer sound will speed up. (When the flash fires, the lamp will remain lit.) About two seconds later, the camera will shoot.
- To cancel shooting after you have triggered the self-timer, press the <MENU> button.



- Even if your face is not detected after you join the others in the shooting area, the camera will shoot about 15 seconds later.
- To change the number of shots, after choosing [C] in step 1, press the <DISP.> button, choose the number of shots (either press the <◀><▶> buttons or turn the [DIAL] dial), and then press the <DISP.> button again. [Blink Detection] (73) is only available for the final shot.

Image Effects (Creative Filters)

Add a variety of effects to images when shooting.

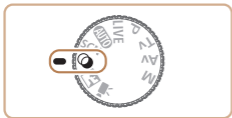

1 Enter [Fn] mode.

- Set the mode dial to [Fn].



2 Choose a shooting mode.

- Press the <FUNC/SET> button, choose [Fn] in the menu, and then choose a shooting mode (43).

3 Shoot.



Still Images

Movies

Shoot in vivid colors (Super Vivid)

- Shots in rich, vivid colors.





Still Images

Movies

Posterized shots (Poster Effect)

- Shots that resemble an old poster or illustration.



- In [] and [] modes, try taking some test shots first, to make sure you obtain the desired results.

Shooting with a Fish-Eye Lens Effect (Fish-Eye Effect)

Shoot with the distorting effect of a fish-eye lens.

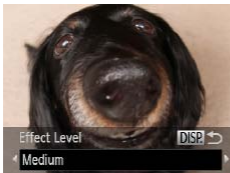

1 Choose [👁].

- Follow steps 1 – 2 in “Image Effects (Creative Filters)” (📖84) and choose [👁].

2 Choose an effect level.

- Press the <DISP.> button, choose an effect level (either press the <◀>▶> buttons or turn the <🔧> dial), and then press the <DISP.> button again.
- A preview is shown of how your shot will look with the effect applied.

3 Shoot.



- Try taking some test shots first, to make sure you obtain the desired results.

Shots Resembling Miniature Models (Miniature Effect)

Creates the effect of a miniature model, by blurring image areas above and below your selected area.

You can also make movies that look like scenes in miniature models by choosing the playback speed before the movie is recorded. People and objects in the scene will move quickly during playback. Note that sound is not recorded.

1 Choose [👉].

- Follow steps 1 – 2 in “Image Effects (Creative Filters)” (📖 84) and choose [👉].
- A white frame is displayed, indicating the image area that will not be blurred.

2 Choose the area to keep in focus.

- Press the <DISP.> button.
- Move the zoom lever to resize the frame, and press the <▲><▼> buttons to move it.





3 For movies, choose the movie playback speed.

- Press the <MENU> button, and then choose the speed by pressing the <◀>> buttons or turning the <⦿> dial.

4 Return to the shooting screen and shoot.

- Press the <MENU> button to return to the shooting screen, and then shoot.

■ Playback Speed and Estimated Playback Time (for One-Minute Clips)

Speed	Playback Time
5x	Approx. 12 sec.
10x	Approx. 6 sec.
20x	Approx. 3 sec.



- The zoom is not available when shooting movies. Be sure to set the zoom before shooting.
- Try taking some test shots first, to make sure you obtain the desired results.



- To switch the orientation of the frame (from horizontal to vertical or vice-versa), press the $\langle \text{FUNC. SET} \rangle$ button in step 2. You can move the frame in vertical orientation by pressing the $\langle \blacktriangleleft \blacktriangleright \rangle$ buttons.
- Holding the camera vertically will change the orientation of the frame.
- Movie image quality is $\boxed{\text{VGA}}$ at an aspect ratio of $\boxed{4:3}$ and $\boxed{\text{HD}}$ at an aspect ratio of $\boxed{16:9}$ (📖 66). These quality settings cannot be changed.

Still Images

Shooting with a Toy Camera Effect (Toy Camera Effect)

This effect makes images resemble shots from a toy camera by vignetting (darker, blurred image corners) and changing the overall color.



1 Choose $\boxed{\text{☒}}$.

- Follow steps 1 – 2 in “Image Effects (Creative Filters)” (📖 84) and choose $\boxed{\text{☒}}$.

2 Choose a color tone.

- Press the $\langle \text{DISP.} \rangle$ button, choose a color tone (either press the $\langle \blacktriangleleft \blacktriangleright \rangle$ buttons or turn the $\langle \text{FUNC. SET} \rangle$ dial), and then press the $\langle \text{DISP.} \rangle$ button again.
- A preview is shown of how your shot will look with the effect applied.

3 Shoot.

Standard	Shots resemble toy camera images.
Warm	Images have a warmer tone than with [Standard].
Cool	Images have a cooler tone than with [Standard].



- Try taking some test shots first, to make sure you obtain the desired results.

Still Images

Movies

Shooting in Monochrome

Shoot images in black and white, sepia, or blue and white.



1 Choose [▣].

- Follow steps 1 – 2 in “Image Effects (Creative Filters)” (📖 84) and choose [▣].

2 Choose a color tone.

- Press the <DISP.> button, choose a color tone (either press the <◀>▶> buttons or turn the <🌀> dial), and then press the <DISP.> button again.
- A preview is shown of how your shot will look with the effect applied.

3 Shoot.

B/W	Black and white shots.
Sepia	Sepia tone shots.
Blue	Blue and white shots.

Discreet Mode

Shoot without activating camera sounds, the flash, or lamp as follows. Use this mode where camera sounds, the flash, and lights are prohibited.

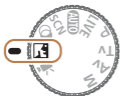

1 Enter mode.

- Set the mode dial to .

2 Shoot.



- In  mode, even playback sounds are muted. Sounds of camera operations are muted, and movie audio is also muted.

Shooting Movies in [] Mode



1 Enter [] mode.

- Set the mode dial to [].
- Black bars displayed on the top and bottom edges of the screen indicate image areas not recorded.

2 Configure the settings to suit the movie (233 – 252).

3 Shoot.

- Press the movie button.
- To stop movie recording, press the movie button again.

Locking or Changing Image Brightness before Shooting

Before shooting, you can lock the exposure or change it in 1/3-stop increments within a range of -2 to +2.



1 Lock the exposure.

- After releasing the shutter button, press the <▲> button to lock the exposure. The exposure shift bar is displayed.
- To unlock the exposure, press the <▲> button again.

2 Adjust the exposure.

- Turn the <⊙> dial to adjust the exposure, as you watch the screen.

3 Shoot (📖92).

4

P Mode

More discerning shots, in your preferred shooting style

- Instructions in this chapter apply to the camera with the mode dial set to **[P]** mode.
- **[P]**: Program AE; AE: Auto Exposure
- Before using a function introduced in this chapter in modes other than **[P]**, make sure the function is available in that mode ( 233 – 252).

Shooting in Program AE ([P] Mode).....	95	Shooting Range and Focusing	107
Image Brightness (Exposure)	96	Flash	117
Color and Continuous Shooting.....	101	Other Settings.....	121

Shooting in Program AE ([P] Mode)

You can customize many function settings to suit your preferred shooting style.



- 1 Enter [P] mode.**
 - Set the mode dial to [P].
- 2 Customize the settings as desired (📖96 – 122), and then shoot.**



- If adequate exposure cannot be obtained when you press the shutter button halfway, shutter speeds and aperture values are displayed in orange. In this case, try adjusting the ISO speed (📖99) or activating the flash (if subjects are dark, 📖117), which may enable adequate exposure.
- Movies can be recorded in [P] mode as well, by pressing the movie button. However, some FUNC. (📖43) and MENU (📖45) settings may be automatically adjusted for movie recording.
- For details on the shooting range in [P] mode, see “Shooting Range” (📖259).



Image Brightness (Exposure)

Still Images

Adjusting Image Brightness (Exposure Compensation)

The standard exposure set by the camera can be adjusted in 1/3-stop increments, in a range of -2 to +2.





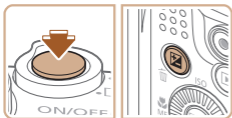

- Press the  button. As you watch the screen, turn the  dial to adjust brightness, and then press the  button again when finished.
- The correction level you specified is now displayed.

Locking Image Brightness / Exposure (AE Lock)

Before shooting, you can lock the exposure, or you can specify focus and exposure separately.



1 Lock the exposure.

- Aim the camera at the subject to shoot with the exposure locked. With the shutter button pressed halfway, press the  button.
-  is displayed, and the exposure is locked.
- To unlock AE, release the shutter button and press the  button again. In this case,  is no longer displayed.

2 Compose the shot and shoot.

- After one shot, AE is unlocked and  is no longer displayed.







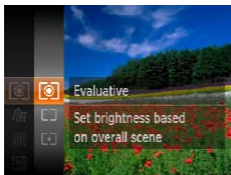

- AE: Auto Exposure
- After the exposure is locked, you can adjust the combination of shutter speed and aperture value by turning the  dial (Program Shift).

Changing the Metering Method

Adjust the metering method (how brightness is measured) to suit shooting conditions as follows.



- Press the <FUNC. SET> button, choose  in the menu, and choose the desired option ( 43).
- The option you configured is now displayed.

 Evaluative	For typical shooting conditions, including backlit shots. Automatically adjusts exposure to match the shooting conditions.
 Center Weighted Avg.	Determines the average brightness of light across the entire image area, calculated by treating brightness in the central area as more important.
 Spot	Metering restricted to within the  (Spot AE Point frame), displayed in the center of the screen.

Changing the ISO Speed

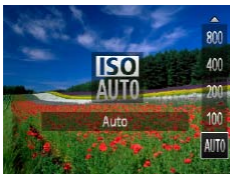

- Press the <▲> button, choose an option (either press the <▲><▼> buttons or turn the <⊙> dial), and then press the <FUNC SET> button.
- The option you configured is now displayed.

ISO AUTO	Automatically adjusts the ISO speed to suit the shooting mode and conditions.	
ISO 100	Low ↑ ↓	For shooting outdoors in fair weather.
ISO 200		For shooting in cloudy conditions, or at twilight.
ISO 400	High	For shooting night scenes, or in dark rooms.
ISO 800		
ISO 1600		



- To view the automatically set ISO speed when the camera is set to **[ISO AUTO]**, press the shutter button halfway.
- Although choosing a lower ISO speed may reduce image graininess, there may be a greater risk of subject blurriness in some shooting conditions.
- Choosing a higher ISO speed will increase shutter speed, which may reduce subject blurriness and increase the flash range. However, shots may look grainy.

Correcting Image Brightness (i-Contrast)

Before shooting, excessively bright or dark image areas (such as faces or backgrounds) can be detected and automatically adjusted to the optimal brightness. Insufficient overall image contrast can also be automatically corrected before shooting to make subjects stand out better.



- Press the <MENU> button, choose [i-Contrast] on the [📷] tab, and then choose [Auto] (📖45).
- Once the setting is complete, [📷i] is displayed.



- Under some shooting conditions, correction may be inaccurate or may cause images to appear grainy.



- You can also correct existing images (📖162).

Color and Continuous Shooting

Still Images

Movies

Adjusting White Balance

By adjusting white balance (WB), you can make image colors look more natural for the scene you are shooting.

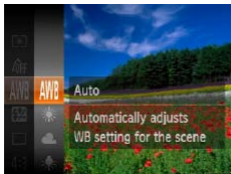

- Press the <FUNC SET> button, choose [AWB] in the menu, and choose the desired option (📖43).
- The option you configured is now displayed.

AWB Auto	Automatically sets the optimal white balance for the shooting conditions.
☀ Day Light	For shooting outdoors in fair weather.
☁ Cloudy	For shooting in cloudy conditions, in the shade, or at twilight.
💡 Tungsten	For shooting under ordinary incandescent (tungsten) lighting and similarly colored fluorescent lighting.
💡 Fluorescent	For shooting under warm-white (or similarly colored) or cool-white fluorescent lighting.
💡 Fluorescent H	For shooting under daylight fluorescent and similarly colored fluorescent lighting.
🎛 Custom	For manually setting a custom white balance (📖102).

Custom White Balance

For image colors that look natural under the light in your shot, adjust white balance to suit the light source where you are shooting. Set the white balance under the same light source that will illuminate your shot.



- Follow the steps in “Adjusting White Balance” (📖101) to choose [📷].
- Aim the camera at a plain white subject, so that the entire screen is white. Press the <DISP.> button.
- The tint of the screen changes once the white balance data has been recorded.



- Colors may look unnatural if you change camera settings after recording white balance data.

Changing Image Color Tones (My Colors)

Change image color tones as desired, such as converting images to sepia or black and white.

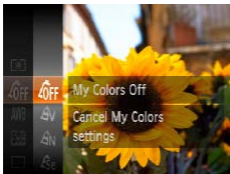

- Press the <FUNC. SET> button, choose [OFF] in the menu, and choose the desired option (104).
- The option you configured is now displayed.

OFF My Colors Off	—
V Vivid	Emphasizes contrast and color saturation, making images sharper.
N Neutral	Tones down contrast and color saturation for subdued images.
Se Sepia	Creates sepia tone images.
BW B/W	Creates black and white images.
P Positive Film	Combines the effects of Vivid Blue, Vivid Green, and Vivid Red to produce intense yet natural-looking colors resembling images on positive film.
L Lighter Skin Tone	Lightens skin tones.
D Darker Skin Tone	Darkens skin tones.
B Vivid Blue	Emphasizes blues in images. Makes the sky, ocean, and other blue subjects more vivid.
G Vivid Green	Emphasizes greens in images. Makes mountains, foliage, and other green subjects more vivid.
R Vivid Red	Emphasizes reds in images. Makes red subjects more vivid.
C Custom Color	Adjust contrast, sharpness, color saturation, and other qualities as desired (104).



- White balance (📖101) cannot be set in [S_{Se}] or [S_{BW}] modes.
- With [A_L] and [A_D] modes, colors other than people's skin tone may change. These settings may not produce the expected results with some skin tones.

Still Images

Movies

Custom Color

Choose the desired level of image contrast, sharpness, color saturation, red, green, blue, and skin tones in a range of 1 – 5.

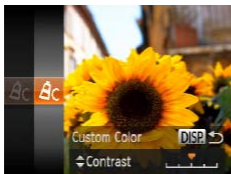

1 Access the setting screen.

- Follow the steps in “Changing Image Color Tones (My Colors)” (📖103) to choose [A_C], and then press the <DISP.> button.

2 Configure the setting.

- Press the <▲><▼> buttons to choose an option, and then specify the value by pressing the <◀><▶> buttons or turning the <🌀> dial.
- For stronger/more intense effects (or darker skin tones), adjust the value to the right, and for weaker/lighter effects (or lighter skin tones), adjust the value to the left.
- Press the <DISP.> button to complete the setting.

Continuous Shooting

Hold the shutter button all the way down to shoot continuously. For details on the continuous shooting speed, see “Continuous Shooting Speed” (📖259).

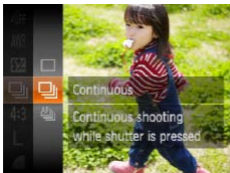



1 Configure the setting.

- Press the <FUNC SET> button, choose [] in the menu, and choose the desired option (📖43).
- The option you configured is now displayed.

2 Shoot.

- Hold the shutter button all the way down to shoot continuously.

Mode	Description
 Continuous	Continuous shooting, with the focus and exposure determined when you press the shutter button halfway.
 Continuous Shooting AF*	Continuous shooting and focusing. [AF Frame] is set to [Center] and cannot be changed.

* In [] mode (📖81), manual focus mode (📖108), or when AF is locked (📖116), [AF] is changed to [LV].



- Cannot be used with the self-timer (📖61) or [Blink Detection] (📖73).
- Shooting may stop momentarily or continuous shooting may slow down depending on shooting conditions, camera settings, and the zoom position.
- As more shots are taken, shooting may slow down.
- Shooting may slow down if the flash fires.



- Continuous shooting is faster in [📷] mode (📖81).

Shooting Range and Focusing

Still Images

Shooting Close-Ups (Macro)

To restrict the focus to subjects at close range, set the camera to [🌻]. For details on the focusing range, see “Shooting Range” (📖259).

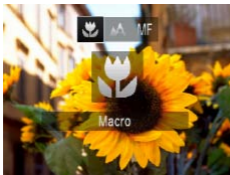

- Press the <◀> button, choose [🌻] (either press the <◀><▶> buttons or turn the <⚙️> dial), and then press the <FUNC SET> button.
- Once the setting is complete, [🌻] is displayed.



- If the flash fires, vignetting may occur.
- In the yellow bar display area below the zoom bar, [🌻] will turn gray and the camera will not focus.



- To prevent camera shake, try mounting the camera on a tripod and shooting with the camera set to [🌻] (📖62).

Shooting in Manual Focus Mode

When focusing is not possible in AF mode, use manual focus. You can specify the general focal position and then press the shutter button halfway to have the camera determine the optimal focal position near the position you specified. For details on the focusing range, see “Shooting Range” (📖259).



MF Indicator

1 Choose [MF].

- Press the <◀> button, choose [MF] (either press the <◀><▶> buttons or turn the <⦿> dial), and then press the <FUNC SET> button.
- [MF] and the MF indicator are displayed.

2 Specify the general focal position.

- Referring to the on-screen MF indicator bar (which shows the distance and focal position) and the magnified display area, press the <▲><▼> buttons or turn the <⦿> dial to specify the general focal position, and then press the <FUNC SET> button.

3 Fine-tune the focus.

- Press the shutter button halfway to have the camera fine-tune the focal position (Safety MF).



- When you focus manually, the AF frame mode (📖110) is [Center] and AF frame size (📖111) is [Normal], and these settings cannot be changed.
- Focusing is possible when using the digital zoom (📖59) or digital tele-converter (📖109), or when using a TV as a display (📖189), but the magnified display will not appear.



- To focus more accurately, try attaching the camera to a tripod to stabilize it.
- To hide the magnified display area, press the <MENU> button and set [MF-Point Zoom] on the [📷] tab to [Off] (📖45).
- To deactivate automatic focus fine-tuning when the shutter button is pressed halfway, press the <MENU> button and set [Safety MF] on the [📷] tab to [Off] (📖45).

Still Images

Movies

Digital Tele-Converter

The focal length of the lens can be increased by approximately 1.6x or 2.0x. This can reduce camera shake because the shutter speed is faster than it would be if you zoomed (including using digital zoom) in to the same zoom factor.



- Press the <MENU> button, choose [Digital Zoom] on the [📷] tab, and then choose the desired option (📖45).
- The view is enlarged and the zoom factor is displayed on the screen.

- ❗ The digital tele-converter cannot be used with digital zoom (📖59) or AF-point zoom (📖72).



- The respective focal lengths when using [1.6x] and [2.0x] are 44.8 – 716.8 mm and 56.0 – 896.0 mm (35mm film equivalent).
- The shutter speed may be equivalent when you move the zoom lever all the way toward <[📷]> for maximum telephoto, and when you zoom in to enlarge the subject to the same size following step 2 in “Zooming In Closer on Subjects (Digital Zoom)” (📖59).

Still Images

Movies

Changing the AF Frame Mode

Change the AF (auto focus) frame mode to suit the shooting conditions as follows.



- Press the <MENU> button, choose [AF Frame] on the [📷] tab, and then choose the desired option (📖45).

Still Images

Movies

Center

One AF frame is displayed in the center. Effective for reliable focusing.



- A yellow AF frame is displayed with [❗] if the camera cannot focus when you press the shutter button halfway.



- To reduce the AF frame size, press the <MENU> button and set [AF Frame Size] on the [📷] tab to [Small] (📖45).
- The AF frame size is set to [Normal] when you use the digital zoom (📖59) or digital tele-converter (📖109), and in manual focus mode (📖108).
- To compose shots so that subjects are positioned at the edge or in a corner, first aim the camera to capture the subject in an AF frame, and then hold the shutter button halfway down. As you continue to hold the shutter button halfway, recompose the shot as desired, and then press the shutter button all the way down (Focus Lock).

Still Images

Movies

■ Face AiAF

- Detects people's faces, and then sets the focus, exposure (evaluative metering only), and white balance ([AWB] only).
- After you aim the camera at the subject, a white frame is displayed around the person's face determined by the camera to be the main subject, and up to two gray frames are displayed around other detected faces.
- When the camera detects movement, frames will follow moving subjects, within a certain range.
- After you press the shutter button halfway, up to nine green frames are displayed around faces in focus.





- If faces are not detected, or when only gray frames are displayed (without a white frame), up to nine green frames are displayed in the areas in focus when you press the shutter button halfway.
- If faces are not detected when Servo AF ( 114) is set to [On], the AF frame is displayed in the center of the screen when you press the shutter button halfway.
- Examples of faces that cannot be detected:
 - Subjects that are distant or extremely close
 - Subjects that are dark or light
 - Faces in profile, at an angle, or partly hidden
- The camera may misinterpret non-human subjects as faces.
- No AF frames are displayed if the camera cannot focus when you press the shutter button halfway.

Choosing Subjects to Focus On (Tracking AF)

Shoot after choosing a subject to focus on as follows.

1 Choose [Tracking AF].

- Follow the steps in “Changing the AF Frame Mode” ( 110) to choose [Tracking AF].
-  is displayed in the center of the screen.



2 Choose a subject to focus on.

- Aim the camera so that [□] is on the desired subject, and then press the <◀> button.
- When the subject is detected, the camera beeps and [□] is displayed. Even if the subject moves, the camera will continue to track the subject within a certain range.
- If no subject is detected, [□] is displayed.
- To cancel tracking, press the <◀> button again.

3 Shoot.

- Press the shutter button halfway. [□] changes to a blue [□], which follows the subject as the camera continues to adjust the focus and exposure (Servo AF) (📖 114).
- Press the shutter button all the way down to shoot.
- Even after your shot, [□] is still displayed and the camera continues to track the subject.



- [Servo AF] (📖 114) is set to [On] and cannot be changed.
- Tracking may not be possible when subjects are too small or move too rapidly, or when subject color or brightness matches that of the background too closely.
- [AF-Point Zoom] on the [📷] tab is not available.
- [👉] is not available.



- The camera can detect subjects even if you press the shutter button halfway without pressing the <◀> button. After your shot, [☐] is displayed in the center of the screen.
- When shooting in [MF] mode (📖 108), press and hold the <◀> button for at least one second.

■ Shooting with Servo AF

This mode helps avoid missing shots of subjects in motion, because the camera continues to focus on the subject and adjust the exposure as long as you press the shutter button halfway.

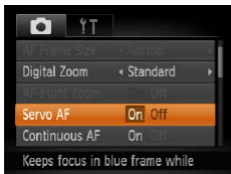

1 Configure the setting.

- Press the <MENU> button, choose [Servo AF] on the [📷] tab, and then choose [On] (📖 45).

2 Focus.

- The focus and exposure are maintained where the blue AF frame is displayed while you are pressing the shutter button halfway.



- Focusing may not be possible in some shooting conditions.
- In low-light conditions, Servo AF may not be activated (AF frames may not turn blue) when you press the shutter button halfway. In this case, the focus and exposure are set according to the specified AF frame mode.
- If adequate exposure cannot be obtained, shutter speeds and aperture values are displayed in orange. Release the shutter button, and then press it halfway again.
- AF lock shooting is not available.
- [AF-Point Zoom] on the [📷] tab is not available.
- Not available when using the self-timer (📖61).

Still Images

Changing the Focus Setting

You can change default camera operation of constantly focusing on subjects it is aimed at, even when the shutter button is not pressed. Instead, you can limit camera focusing to the moment you press the shutter button halfway.

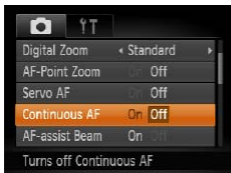

- Press the <MENU> button, choose [Continuous AF] on the [📷] tab, and then choose [Off] (📖45).

On	Helps avoid missing sudden photo opportunities, because the camera constantly focuses on subjects until you press the shutter button halfway.
Off	Conserves battery power, because the camera does not focus constantly.

Shooting with the AF Lock

The focus can be locked. After you lock the focus, the focal position will not change even when you release your finger from the shutter button.



1 Lock the focus.

- With the shutter button pressed halfway, press the <◀▶> button.
- The focus is now locked, and [MF] and the MF indicator are displayed.
- To unlock the focus, hold the shutter button halfway down and press the <◀▶> button again.

2 Compose the shot and shoot.

Flash

Still Images

Changing the Flash Mode

You can change the flash mode to match the shooting scene. For details on the flash range, see “Flash Range” (📖258).



1 Lift the flash.

2 Configure the setting.

- Press the <▶> button, choose a flash mode (either press the <◀><▶> buttons or turn the <⚙️> dial), and then press the <FUNC SET> button.
- The option you configured is now displayed.



- The setting screen cannot be accessed by pressing the <▶> button when the flash is lowered. Lift the flash with your finger in advance.

⚡ Auto

Fires automatically in low-light conditions.

⚡ On

Fires for each shot.

⚡* Slow Synchro

Fires to illuminate the main subject (such as people) while shooting at a slower shutter speed to illuminate backgrounds out of flash range.



- In [⚡] mode, mount the camera on a tripod or take other measures to keep it still and prevent camera shake. Additionally, you should set [IS Mode] to [Off] when using a tripod or other means to secure the camera (📖 122).
- In [⚡] mode, even after the flash fires, ensure that the main subject does not move until the shutter sound is finished playing.

Adjusting the Flash Exposure Compensation

Just as with regular exposure compensation (📖96), you can adjust the flash exposure from -2 to +2 stops, in 1/3-stop increments.

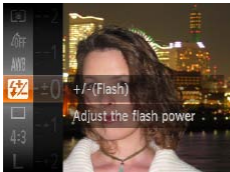

- Press the <FUNC. SET> button, choose [Fv] in the menu, and adjust the setting by either pressing the <▲><▼> buttons or turning the <DISP.> dial (📖43).
- Once the setting is complete, [Fv] is displayed.



- When there is a risk of overexposure, the camera automatically adjusts the shutter speed or aperture value during the flash shots to reduce washed-out highlights and shoot at optimal exposure. However, you can deactivate automatic adjustment of the shutter speed and aperture value by accessing MENU (📖45) and choosing [CAMERA] tab > [Flash Settings] > [Safety FE] > [Off].
- You can also configure the flash exposure compensation by accessing MENU (📖45) and choosing [CAMERA] tab > [Flash Settings] > [Flash Exp. Comp].
- You can also access the [Flash Settings] MENU screen when the flash is up by pressing the <▶> button and immediately pressing the <MENU> button.

Shooting with the FE Lock

Just as with the AE lock (📖97), you can lock the exposure for the flash shots.

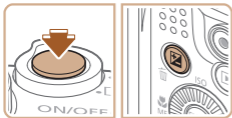

- 1 Lift the flash and set the flash to [⚡] (📖117).**
- 2 Lock the flash exposure.**
 - Aim the camera at the subject to shoot with the exposure locked. With the shutter button pressed halfway, press the <⚡> button.
 - The flash fires, and when [✱] is displayed, the flash output level is retained.
 - To unlock FE, release the shutter button and press the <⚡> button again. In this case, [✱] is no longer displayed.
- 3 Compose the shot and shoot.**
 - After one shot, FE is unlocked and [✱] is no longer displayed.



- FE: Flash Exposure

Other Settings

Still Images

Changing the Compression Ratio (Image Quality)

Choose from two compression ratios, [S] (Super Fine) and [] (Fine), as follows. For guidelines on how many shots at each compression ratio can fit on a memory card, see “Number of 4:3 Shots per Memory Card” (4257).

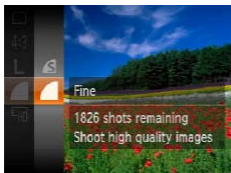

- Press the <FUNC SET> button, choose [] in the menu, and choose the desired option (43).

Changing the IS Mode Settings

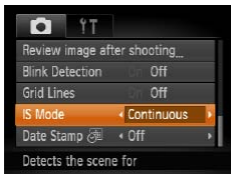

- Press the <MENU> button, choose [IS Mode] on the [📷] tab, and then press the <◀><▶> buttons to choose the desired option (📖45).

Continuous	Optimal image stabilization for the shooting conditions is automatically applied (Intelligent IS) (📖57).
Shoot Only*	Image stabilization is active only at the moment of shooting.
Off	Deactivates image stabilization.

* The setting is changed to [Continuous] for movie recording.



- If image stabilization cannot prevent camera shake, mount the camera on a tripod or take other measures to hold it still. In this case, set [IS Mode] to [Off].

5

Tv, Av, and M Mode

Take smarter, more sophisticated shots

- Instructions in this chapter apply to the camera as set to the respective mode.

**Specific Shutter Speeds
([Tv] Mode).....124**

**Specific Aperture Values
([Av] Mode).....125**

**Specific Shutter Speeds
and Aperture Values
([M] Mode).....126**

Specific Shutter Speeds ([Tv] Mode)

Set your preferred shutter speed before shooting as follows. The camera automatically adjusts the aperture value to suit your shutter speed.

For details on available shutter speeds, see “Shutter Speed” (📖260).



1 Enter [Tv] mode.

- Set the mode dial to [Tv].

2 Set the shutter speed.

- Turn the <🔍> dial to set the shutter speed.



- With shutter speeds of 1.3 seconds or slower, there will be a delay before you can shoot again, as images are processed to remove noise.
- When shooting at low shutter speeds on a tripod, you should set [IS Mode] to [Off] (📖122).
- Maximum shutter speed with the flash is 1/2000 second. If you specify a faster speed, the camera will automatically reset the speed to 1/2000 second before shooting.
- Orange display of aperture values when you press the shutter button halfway indicates that the settings deviate from standard exposure. Adjust the shutter speed until the aperture value is displayed in white, or use safety shift (📖125).



- [Tv]: Time value

Specific Aperture Values ([Av] Mode)

Set your preferred aperture value before shooting as follows. The camera automatically adjusts the shutter speed to suit your aperture value.

For details on available aperture values, see “Aperture” (📖260).



- 1 Enter [Av] mode.**
 - Set the mode dial to [Av].
- 2 Set the aperture value.**
 - Turn the <🔍> dial to set the aperture value.



- Orange display of shutter speeds when you press the shutter button halfway indicates that the settings deviate from standard exposure. Adjust the aperture value until the shutter speed is displayed in white, or use safety shift (see below).



- [Av]: Aperture value (size of the opening made by the iris in the lens)
- To avoid exposure problems in [Tv] and [Av] modes, you can have the camera automatically adjust the shutter speed or aperture value, even when standard exposure cannot otherwise be obtained. Press the <MENU> button and set [Safety Shift] on the [📷] tab to [On] (📖45).
However, safety shift is disabled when the flash fires.

Specific Shutter Speeds and Aperture Values ([M] Mode)

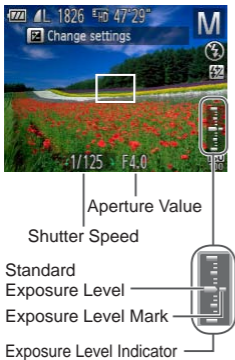

Follow these steps before shooting to set your preferred shutter speed and aperture value to obtain the desired exposure. For details on available shutter speeds and aperture values, see “Shutter Speed” (📖260) and “Aperture” (📖260).



1 Enter [M] mode.

- Set the mode dial to [M].

2 Configure the setting.

- Press the  button, choose adjustment of shutter speed or aperture value, and turn the  dial to specify a value.
- An exposure level mark based on your specified value is shown on the exposure level indicator for comparison to the standard exposure level.
- The exposure level mark is shown in orange when the difference from standard exposure exceeds 2 stops. [-2] or [+2] is displayed in orange in the lower right when you press the shutter button halfway.



- After you set the shutter speed or aperture value, the exposure level may change if you adjust the zoom or recompose the shot.
- Screen brightness may change depending on your specified shutter speed or aperture value. However, screen brightness remains the same when the flash is up and the mode is set to [⚡].
- To have the setting you did not configure in step 2 (whether shutter speed or aperture value) automatically adjusted to obtain standard exposure, hold the shutter button halfway and press the <[☒]> button. Note that standard exposure may not be possible with some settings.



- **[M]**: Manual
- Calculation of standard exposure is based on the specified metering method (📖98).

Adjusting the Flash Output

Choose from the three flash levels in **[M]** mode.

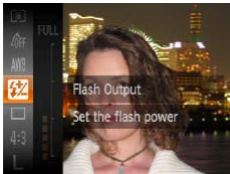

1 Enter **[M]** mode.

- Set the mode dial to **[M]**.

2 Configure the setting.

- Press the **<FUNC SET>** button, choose **[FZ]** in the menu, and adjust the setting by either pressing the **<▲>****<▼>** buttons or turning the **<DISP>** dial (📖43).
- Once the setting is complete, **[FZ]** is displayed.



- You can also set the flash level by accessing MENU (📖45) and choosing **[📷]** tab > [Flash Settings] > [Flash Output].
- You can set the flash level in **[Tv]** or **[Av]** mode by accessing MENU (📖45) and choosing **[📷]** tab > [Flash Settings] > [Flash Mode] > [Manual].
- You can also access the [Flash Settings] MENU screen by pressing the **<▶>** button and then the **<MENU>** button.

6

Playback Mode

Have fun reviewing your shots, and browse or edit them in many ways

- To prepare the camera for these operations, press the <▶> button to enter Playback mode.



- It may not be possible to play back or edit images that were renamed or already edited on a computer, or images from other cameras.

Viewing	130	Rotating Images.....	153
Browsing and Filtering Images.....	135	Tagging Images as Favorites	155
Image Viewing Options	138	Editing Still Images	157
Protecting Images	143	Editing Movies	165
Erasing Images	149		

Viewing

After shooting images or movies, you can view them on the screen as follows.



1 Enter Playback mode.

- Press the <▶> button.
- Your last shot is displayed.

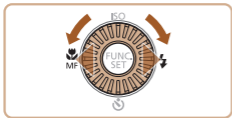





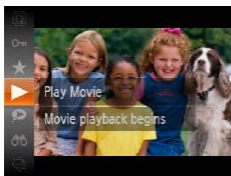

2 Browse through your images.







- To view the previous image, press the <◀> button or turn the <⌚> dial counterclockwise. To view the next image, press the <▶> button or turn the <⌚> dial clockwise.
- Press and hold the <◀><▶> buttons to browse through images quickly. Images appear grainy at this time.





- To access Scroll Display mode, turn the  dial rapidly. In this mode, turn the  dial to browse through images.
- To return to single-image display, press the  button.
- To browse images grouped by shooting date, press the   buttons in Scroll Display mode.
- Movies are identified by a  icon. To play movies, go to step 3.

3 Play movies.

- To start playback, press the  button, choose  (either press the   buttons or turn the  dial), and then press the  button again.



Volume Indicator

4 Adjust the volume.

- Press the <▲><▼> buttons to adjust the volume.
- To adjust the volume when the volume indicator is no longer displayed, press the <▲><▼> buttons.

5 Pause playback.

- To pause or resume playback, press the <FUNC/SET> button.
- After the movie is finished, [SET▶] is displayed.



- To switch to Shooting mode from Playback mode, press the shutter button halfway.
- To deactivate Scroll Display, press the <MENU> button, choose [Scroll Display] on the [▶] tab, and then choose [Off].
- If you prefer to have the most recent shot displayed when you enter Playback mode, press the <MENU> button, and on the [▶] tab, choose [Resume] and then [Last shot].
- To change the transition shown between images, press the <MENU> button, choose [Transition] on the [▶] tab, and then choose the desired effect.

Switching Display Modes

Press the <DISP.> button to view other information on the screen, or to hide the information. For details on the information displayed, see “Playback (Detailed Information Display)” (📖 231).



No Information Display



Simple Information Display



Detailed Information Display

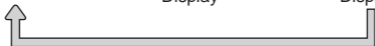

Overexposure Warning (for Image Highlights)

Washed-out highlights in the image flash on the screen in detailed information display (📖 133).

Histogram

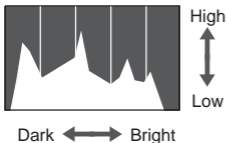

- The graph in detailed information display ( 133) is a histogram showing the distribution of brightness in the image. The horizontal axis represents the degree of brightness, and the vertical axis, how much of the image is at each level of brightness. Viewing the histogram is a way to check exposure.

Browsing and Filtering Images

Still Images



Movies

Navigating through Images in an Index

By displaying multiple images in an index, you can quickly find the images you are looking for.









1 Display images in an index.

- Move the zoom lever toward  to display images in an index. Moving the lever again will increase the number of images shown.
- To display fewer images, move the zoom lever toward . Fewer images are shown each time you move the lever.







2 Choose an image.









- Turn the  dial to scroll through the images.
- Press the     buttons to choose an image.
- An orange frame is displayed around the selected image.
- Press the  button to view the selected image in single-image display.

Finding Images Matching Specified Conditions



Find desired images quickly on a memory card full of images by filtering image display according to your specified conditions. You can also protect (📖143) or delete (📖149) these images all at once.

 People	Displays images with detected faces.
 Shot Date	Displays the images shot on a specific date.
 Favorites	Displays images tagged as favorites (📖155).
 Still image/Movie	Displays only still images or movies.

1 Choose a search condition.

- Press the  button, choose [👤] in the menu, and choose a condition (📖43).
- When you have selected [] or [], choose the condition by pressing the     buttons on the screen displayed, and then press the  button.

2 View the filtered images.

- Images matching your conditions are displayed in yellow frames. To view only these images, press the   buttons.
- To cancel filtered display, choose [] in step 1.



- When the camera has found no corresponding images for some conditions, those conditions will not be available.



- To show or hide information, press the <DISP.> button in step 2.
- Options for viewing the images found (in step 2) include “Navigating through Images in an Index” (📖135), “Magnifying Images” (📖138), and “Viewing Slideshows” (📖139). You can protect, erase, or print all images found or add them to a photobook by choosing [Select All Images in Search] in “Protecting Images” (📖143), “Erasing Multiple Images at Once” (📖150), “Adding Images to the Print List (DPOF)” (📖207), or “Adding Images to a Photobook” (📖213).
- If you edit images and save them as new images (📖158 – 164), a message is displayed, and the images that were found are no longer shown.

Image Viewing Options

Still Images

Magnifying Images



Approximate Position
of Displayed Area

1 Magnify an image.

- Moving the zoom lever toward **<Q>** will zoom in and magnify the image. You can magnify images up to about 10x by continuing to hold the zoom lever.
- To zoom out, move the zoom lever toward **<□>**. You can return to single-image display by continuing to hold it.

2 Move the display position and switch images as needed.

- To move the display position, press the **<▲><▼><◀><▶>** buttons.
- To switch to other images while zoomed, turn the **<⊙>** dial.



- You can return to single-image display from magnified display by pressing the **<MENU>** button.

Viewing Slideshows

Automatically play back images from a memory card as follows. Each image is displayed for about three seconds.

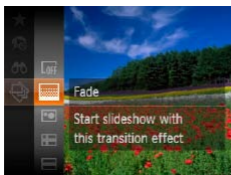

Choose a slideshow transition and start playback.

- Press the <FUNC-SET> button, choose [] in the menu, and choose the desired option (📖43).
- The slideshow will start after [Loading image] is displayed for a few seconds.
- Press the <MENU> button to stop the slideshow.



- The camera's power-saving functions (📖39) are deactivated during slideshows.



- To pause or resume slideshows, press the <FUNC-SET> button.
- You can switch to other images during playback by pressing the <<>> buttons or turning the <DIAL> dial. For fast-forward or fast-rewind, hold the <<>> buttons down.
- In image search mode (📖136), only images matching search conditions are played.

■ Changing Slideshow Settings

You can set up slideshows to repeat, and you can change the transitions between images and the display duration of each image.

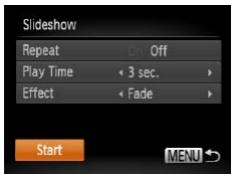

1 Access the setting screen.

- Press the <MENU> button, and then choose [Slideshow] on the [▶] tab (📖 45).

2 Configure the settings.

- Choose a menu item to configure, and then choose the desired option (📖 45).
- To start the slideshow with your settings, choose [Start] and press the <FUNC SET> button.
- To return to the menu screen, press the <MENU> button.



- [Play Time] cannot be modified when [Bubble] is chosen in [Effect].

Auto Playback of Related Images (Smart Shuffle)

Based on the current image, the camera offers four images that you may wish to view. After you choose to view one of those images, the camera offers four more images. This is an enjoyable way to play back images in an unexpected order. Try this feature after you have taken many shots, in many kinds of scenes.

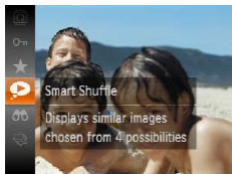

1 Choose Smart Shuffle.

- Press the <FUNC SET> button, and then choose [Smart Shuffle] in the menu (43).
- Four candidate images are displayed.



2 Choose an image.

- Press the <▲><▼><◀><▶> buttons to choose the image you want to view next.
- Your chosen image is displayed in the center, surrounded by the next four candidate images.
- For full-screen display of the center image, press the <FUNC SET> button. To restore the original display, press the <FUNC SET> button again.
- Press the <MENU> button to restore single-image display.



- Only still images shot with this camera are played back using Smart Shuffle.
- Smart Shuffle is not available in the following cases:
 - There are less than 50 shots taken with this camera
 - An unsupported image is currently displayed
 - Images are shown in filtered display ( 136)

Protecting Images

Protect important images to prevent accidental erasure by the camera (📖 149).



- Press the <FUNC SET> button, and then choose [ON] in the menu (📖 43). [Protected] is displayed.
- To cancel protection, repeat this process and choose [OFF] again, and then press the <FUNC SET> button.



- Protected images on a memory card will be erased if you format the card (📖 176, 178).



- Protected images cannot be erased using the camera's erasure function. To erase them this way, first cancel protection.

Using the Menu

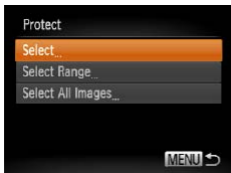
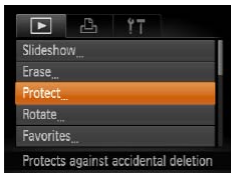

1 Access the setting screen.

- Press the <MENU> button and choose [Protect] on the [▶] tab (📖45).

2 Choose a selection method.

- Choose a menu item and an option as desired (📖45).
- To return to the menu screen, press the <MENU> button.





Choosing Images Individually

1 Choose [Select].





- Following step 2 in “Using the Menu” (📖 144), choose [Select] and press the  button.



2 Choose an image.

- Press the <> buttons or turn the  dial to choose an image, and then press the  button. [On] is displayed.
- To cancel selection, press the  button again. [On] is no longer displayed.
- Repeat this process to specify other images.

3 Protect the image.

- Press the <MENU> button. A confirmation message is displayed.
- Press the <> buttons or turn the  dial to choose [OK], and then press the  button.



- Images will not be protected if you switch to Shooting mode or turn the camera off before finishing the setup process in step 3.

Selecting a Range

1 Choose [Select Range].



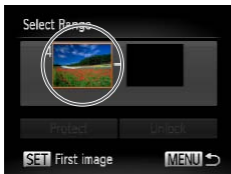

- Following step 2 in “Using the Menu” (📖 144), choose [Select Range] and press the  button.





2 Choose a starting image.

- Press the  button.



- Press the   buttons or turn the  dial to choose an image, and then press the  button.

3 Choose an ending image.

- Press the  button to choose [Last image], and then press the  button.





- Press the <◀><▶> buttons or turn the <⦿> dial to choose an image, and then press the <FUNC SET> button.
- Images before the first image cannot be selected as the last image.

4 Protect the images.

- Press the <▼> button to choose [Protect], and then press the <FUNC SET> button.







- You can also choose the first or last image by turning the <⦿> dial when the top screen in steps 2 and 3 is displayed.

Specifying All Images at Once

1 Choose [Select All Images].

- Following step 2 in “Using the Menu” (📖 144), choose [Select All Images] and press the  button.

2 Protect the images.

- Press the   buttons or turn the  dial to choose [Protect], and then press the  button.



- To cancel protection for groups of images, choose [Unlock] in step 4 of “Selecting a Range” or in step 2 of “Specifying All Images at Once”.

Erasing Images

You can choose and erase unneeded images one by one. Be careful when erasing images, because they cannot be recovered. However, protected images (📖 143) cannot be erased.

1 Choose an image to erase.

- Press the <◀><▶> buttons or turn the <⊙> dial to choose an image.



2 Erase the image.

- Press the <🗑️> button.
- After [Erase?] is displayed, press the <◀><▶> buttons or turn the <⊙> dial to choose [Erase], and then press the <FUNC SET> button.
- The current image is now erased.
- To cancel erasure, press the <◀><▶> buttons or turn the <⊙> dial to choose [Cancel], and then press the <FUNC SET> button.

Erasing Multiple Images at Once

You can choose multiple images to erase at once. Be careful when erasing images, because they cannot be recovered. However, protected images (📖143) cannot be erased.

Choosing a Selection Method

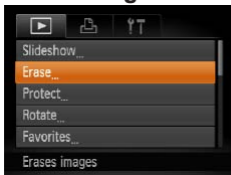

1 Access the setting screen.

- Press the <MENU> button, and then choose [Erase] on the [▶] tab (📖45).

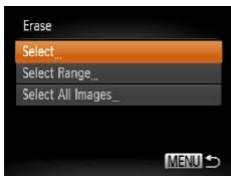

2 Choose a selection method.

- Choose a menu item and an option as desired (📖45).
- To return to the menu screen, press the <MENU> button.

■ Choosing Images Individually

1 Choose [Select].

- Following step 2 in “Choosing a Selection Method” (📖150), choose [Select] and press the <FUNC SET> button.



2 Choose an image.

- Once you choose an image following step 2 in “Choosing Images Individually” (📖145), [✓] is displayed.
- To cancel selection, press the <FUNC SET> button again. [✓] is no longer displayed.
- Repeat this process to specify other images.

3 Erase the image.

- Press the <MENU> button. A confirmation message is displayed.
- Press the <◀>> buttons or turn the <⦿> dial to choose [OK], and then press the <FUNC SET> button.



Selecting a Range



1 Choose [Select Range].

- Following step 2 in “Choosing a Selection Method” (📖150), choose [Select Range] and press the  button.

2 Choose images.

- Follow steps 2 – 3 in “Selecting a Range” (📖146) to specify images.

3 Erase the images.

- Press the  button to choose [Erase], and then press the  button.







Specifying All Images at Once

1 Choose [Select All Images].

- Following step 2 in “Choosing a Selection Method” (📖150), choose [Select All Images] and press the  button.

2 Erase the images.

- Press the   buttons or turn the  dial to choose [OK], and then press the  button.

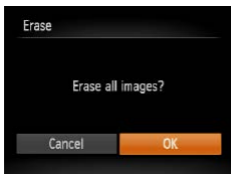

Rotating Images

Change the orientation of images and save them as follows.

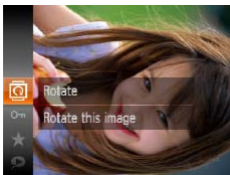

1 Choose [Q].

- Press the <FUNC SET> button, and then choose [Q] in the menu (📖43).

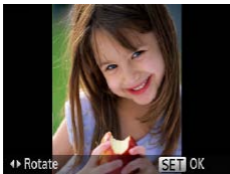

2 Rotate the image.

- Press the <◀> or <▶> button, depending on the desired direction. Each time you press the button, the image is rotated 90°. Press the <FUNC SET> button to complete the setting.

Using the Menu

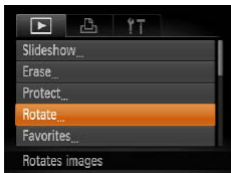

1 Choose [Rotate].

- Press the <MENU> button and choose [Rotate] on the [▶] tab (📖45).



2 Rotate the image.

- Press the <◀>>▶> buttons or turn the <🌀> dial to choose an image.
- The image is rotated 90° each time you press the <FUNC SET> button.
- To return to the menu screen, press the <MENU> button.



- Movies with an image quality of [E-HD] cannot be rotated.
- Rotation is not possible when [Auto Rotate] is set to [Off] (📖154).

Deactivating Auto Rotation

Follow these steps to deactivate automatic image rotation, which rotates images based on the current camera orientation.

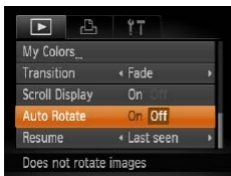

- Press the <MENU> button, choose [Auto Rotate] on the [▶] tab, and then choose [Off] (📖45).



- Images cannot be rotated (📖153) when you set [Auto Rotate] to [Off]. Additionally, images already rotated will be displayed in the original orientation.
- In Smart Shuffle (📖141) mode, even if [Auto Rotate] is set to [Off], images shot vertically will be displayed vertically, and rotated images will be displayed in the rotated orientation.

Tagging Images as Favorites

You can organize images by tagging them as favorites. By choosing a category in filtered playback, you can restrict the following operations to all of those images.

- Viewing (📖130), Viewing Slideshows (📖139), Protecting Images (📖143), Erasing Images (📖149), Adding Images to the Print List (DPOF) (📖207), Adding Images to a Photobook (📖213)

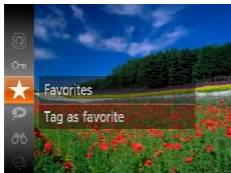

- Press the <FUNC SET> button, and then choose [★] in the menu (📖43).
- [Tagged as Favorite] is displayed.
- To untag the image, repeat this process and choose [★] again, and then press the <FUNC SET> button.

Using the Menu

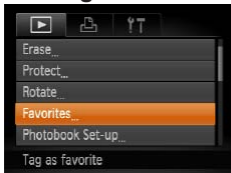

1 Choose [Favorites].

- Press the <MENU> button and choose [Favorites] on the [▶] tab (📖45).

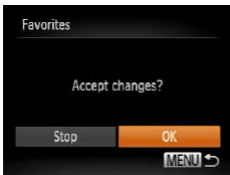

2 Choose an image.

- Press the <◀><▶> buttons or turn the <⦿> dial to choose an image, and then press the <FUNC SET> button. [★] is displayed.
- To untag the image, press the <FUNC SET> button again. [★] is no longer displayed.
- Repeat this process to choose additional images.

3 Finish the setup process.

- Press the <MENU> button. A confirmation message is displayed.
- Press the <◀><▶> buttons or turn the <⦿> dial to choose [OK], and then press the <FUNC SET> button.



- Images will not be tagged as favorites if you switch to Shooting mode or turn the camera off before finishing the setup process in step 3.



- Favorite images will have a three-star rating (★★★☆☆) when transferred to computers running Windows 8, Windows 7, or Windows Vista. (Does not apply to movies.)

Editing Still Images



- Image editing (📖 157 – 164) is only available when the memory card has sufficient free space.

Still Images

Resizing Images

Save a copy of images at a lower resolution.

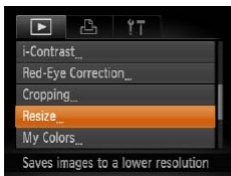

1 Choose [Resize].

- Press the <MENU> button and choose [Resize] on the [▶] tab (📖 45).

2 Choose an image.

- Press the <◀>> buttons or turn the <🕒> dial to choose an image, and then press the <FUNC. SET> button.

3 Choose an image size.

- Press the <◀>> buttons or turn the <🕒> dial to choose the size, and then press the <FUNC. SET> button.
- [Save new image?] is displayed.





4 Save the new image.

- Press the <◀><▶> buttons or turn the <⊙> dial to choose [OK], and then press the <FUNC SET> button.
- The image is now saved as a new file.

5 Review the new image.

- Press the <MENU> button. [Display new image?] is displayed.
- Press the <◀><▶> buttons or turn the <⊙> dial to choose [Yes], and then press the <FUNC SET> button.
- The saved image is now displayed.



- Editing is not possible for images shot at a resolution of [S] (📖 67) or saved as [S] in step 3.





- Images cannot be resized to a higher resolution.

Cropping



You can specify a portion of an image to save as a separate image file.



1 Choose [Cropping].

- Press the <MENU> button, and then choose [Cropping] on the  tab ( 45).

2 Choose an image.

- Press the <◀><▶> buttons or turn the  dial to choose an image, and then press the  button.

Cropping Area

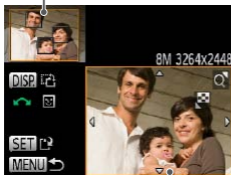

Preview of Image After Cropping

Resolution After Cropping



3 Adjust the cropping area.

- A frame is displayed around the portion of the image to be cropped.
- The original image is shown in the upper left, and a preview of the image as cropped is shown in the lower right.
- To resize the frame, move the zoom lever.
- To move the frame, press the <▲><▼><◀><▶> buttons.
- To change the frame orientation, press the <DISP.> button.
- Faces detected in the image are enclosed in gray frames in the upper-left image. To crop the image based on this frame, turn the <◉> dial to switch to the other frame.
- Press the <FUNC. SET> button.

4 Save as a new image and review.

- Follow steps 4 – 5 in “Resizing Images” (📖158).



- Editing is not possible for images shot at a resolution of [S] (📖67) or resized to [S] (📖157).



- Images supported for cropping will have the same aspect ratio after cropping.
- Cropped images will have a lower resolution than uncropped images.

Still Images

Changing Image Color Tones (My Colors)

You can adjust image colors and then save the edited image as a separate file. For details on each option, see “Changing Image Color Tones (My Colors)” (📖103).

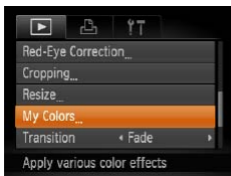

1 Choose [My Colors].

- Press the <MENU> button, and then choose [My Colors] on the [▶] tab (📖45).

2 Choose an image.

- Press the <◀>>> buttons or turn the <⦿> dial to choose an image, and then press the <FUNC SET> button.

3 Choose an option.

- Press the <◀>>> buttons or turn the <⦿> dial to choose an option, and then press the <FUNC SET> button.



4 Save as a new image and review.

- Follow steps 4 – 5 in “Resizing Images” (📖 158).



- Image quality of pictures you repeatedly edit this way will be a little lower each time, and you may not be able to obtain the desired color.



- The color of images edited using this function may vary slightly from the color of images shot using My Colors (📖 103).

Correcting Image Brightness (i-Contrast)

Excessively dark image areas (such as faces or backgrounds) can be detected and automatically adjusted to the optimal brightness. Insufficient overall image contrast is also automatically corrected, to make subjects stand out better. Choose from four correction levels, and then save the image as a separate file.

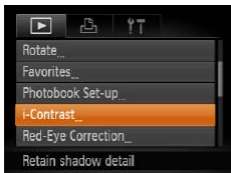

1 Choose [i-Contrast].

- Press the <MENU> button, and then choose [i-Contrast] on the [▶] tab (📖 45).

2 Choose an image.

- Press the <◀>>> buttons or turn the <🔘> dial to choose an image, and then press the <FUNC SET> button.



3 Choose an option.

- Press the <◀>> buttons or turn the <⦿> dial to choose an option, and then press the <FUNC SET> button.

4 Save as a new image and review.

- Follow steps 4 – 5 in “Resizing Images” (📖158).



- For some images, correction may be inaccurate or may cause images to appear grainy.
- Images may look grainy after repeated editing using this function.



- If [Auto] does not produce the expected results, try correcting images using [Low], [Medium], or [High].

Correcting Red-Eye

Automatically corrects images affected by red-eye. You can save the corrected image as a separate file.



1 Choose [Red-Eye Correction].

- Press the <MENU> button, and then choose [Red-Eye Correction] on the [📺] tab (📖45).

2 Choose an image.

- Press the <◀><▶> buttons or turn the <⊙> dial to choose an image.

3 Correct the image.

- Press the <FUNC SET> button.
- Red-eye detected by the camera is now corrected, and frames are displayed around corrected image areas.
- Enlarge or reduce images as needed. Follow the steps in “Magnifying Images” (📖138).

4 Save as a new image and review.

- Press the <▲><▼><◀><▶> buttons or turn the <⊙> dial to choose [New File], and then press the <FUNC SET> button.
- The image is now saved as a new file.
- Follow step 5 in “Resizing Images” (📖158).



- Some images may not be corrected accurately.
- To overwrite the original image with the corrected image, choose [Overwrite] in step 4. In this case, the original image will be erased.
- Protected images cannot be overwritten.

Editing Movies

You can cut movies to remove unneeded portions at the beginning or end.

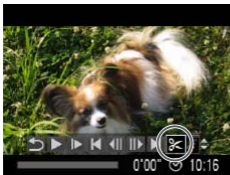

Movie Editing Panel

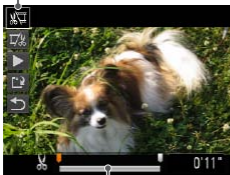

Movie Editing Bar

1 Choose [F/C].

- Following steps 1 – 5 in “Viewing” (130), choose [F/C] and press the <FUNC SET> button.
- The movie editing panel and editing bar are now displayed.

2 Specify portions to cut.

- Press the <▲><▼> buttons to choose [F/C] or [E/C].
- To view the portions you can cut (identified by [C]) on the screen), press the <◀><▶> buttons or turn the <◂> dial to move [C]. Cut the beginning of the movie (from [C]) by choosing [F/C], and cut the end of the movie by choosing [E/C].
- If you move [C] to a position other than a [C] mark, in [F/C] the portion before the nearest [C] mark on the left will be cut, while in [E/C] the portion after the nearest [C] mark on the right will be cut.

3 Review the edited movie.

- Press the <▲><▼> buttons to choose [▶], and then press the <FUNC SET> button. The edited movie is now played.
- To edit the movie again, repeat step 2.
- To cancel editing, press the <▲><▼> buttons to choose [↶]. Press the <FUNC SET> button, choose [OK] (either press the <◀><▶> buttons or turn the <DIAL> dial), and then press the <FUNC SET> button again.

4 Save the edited movie.

- Press the <▲><▼> buttons to choose [⏏], and then press the <FUNC SET> button.
- Press the <▲><▼><◀><▶> buttons or turn the <DIAL> dial to choose [New File], and then press the <FUNC SET> button.
- The movie is now saved as a new file.

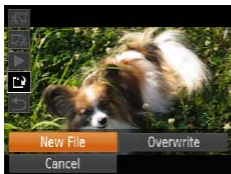



- To overwrite the original movie with the cut one, choose [Overwrite] in step 4. In this case, the original movie will be erased.
- If the memory card lacks sufficient space, only [Overwrite] will be available.
- Movies may not be saved if the battery pack runs out while saving is in progress.
- When editing movies, you should use a fully charged battery pack or an AC adapter kit (sold separately, 📖186).

7

Setting Menu

Customize or adjust basic camera functions for greater convenience

Adjusting Basic Camera Functions	169
---	------------

Adjusting Basic Camera Functions

Functions can be configured on the [F/T] tab. Customize commonly used functions as desired, for greater convenience (📖45).

Silencing Camera Operations

Silence camera sounds and movies as follows.

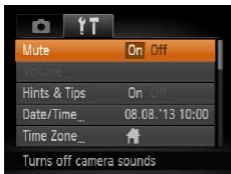

- Choose [Mute], and then choose [On].



- Operation can also be silenced by holding down the <DISP.> button as you turn the camera on.
- Sound is not played during movies (📖130) if you mute camera sounds. To restore sound during movies, press the <▲> button. Adjust volume with the <▲><▼> buttons, as needed.
- Sound settings cannot be changed in [L/3] mode (📖91).

Adjusting the Volume

Adjust the volume of individual camera sounds as follows.



- Choose [Volume], and then press the <FUNC SET> button.
- Choose an item, and then press the <◀><▶> buttons to adjust the volume.

Hiding Hints and Tips

Hints and tips are normally shown when you choose FUNC. (📖43) or MENU (📖45) items. If you prefer, you can deactivate this information.

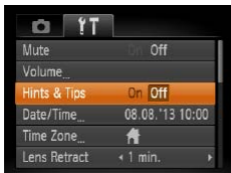

- Choose [Hints & Tips], and then choose [Off].

Date and Time

Adjust the date and time as follows.

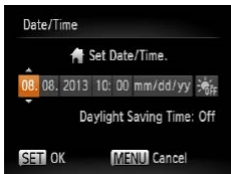

- Choose [Date/Time], and then press the <FUNC/SET> button.
- Press the <◀>> buttons to choose an option, and then adjust the setting, either by pressing the <▲><▼> buttons or turning the <🌀> dial.







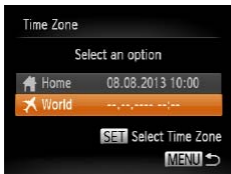





World Clock

To ensure that your shots will have the correct local date and time when you travel abroad, simply register the destination in advance and switch to that time zone. This convenient feature eliminates the need to change the Date/Time setting manually.

Before using the world clock, be sure to set the date and time and your home time zone, as described in “Setting the Date and Time” (📖26).



1 Specify your destination.

- Choose [Time Zone], and then press the  button.
- Press the   buttons or turn the  dial to choose [ World], and then press the  button.
- Press the   buttons or turn the  dial to choose the destination.
- To set daylight saving time (1 hour ahead), press the   buttons to choose [].
- Press the  button.

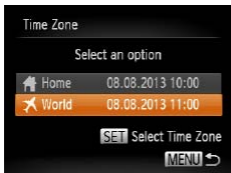

2 Switch to the destination time zone.

- Press the <▲><▼> buttons or turn the <⊙> dial to choose [World], and then press the <MENU> button.
- [] is now shown on the shooting screen (229).



- Adjusting the date or time while in [] mode (28) will automatically update your [Home] time and date.

Lens Retraction Timing

The lens is normally retracted for safety about one minute after you press the <▶> button in Shooting mode (38). To have the lens retracted immediately after you press the <▶> button, set the retraction timing to [0 sec.].

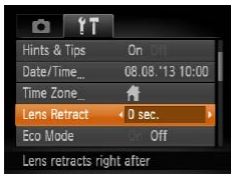

- Choose [Lens Retract], and then choose [0 sec.].

Using Eco Mode

This function allows you to conserve battery power in Shooting mode. When the camera is not in use, the screen quickly darkens to reduce battery consumption.

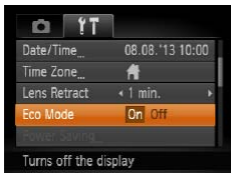

1 Configure the setting.

- Choose [Eco Mode], and then choose [On].
- [ECO] is now shown on the shooting screen (📖229).
- The screen darkens when the camera is not used for approximately two seconds; approximately ten seconds after darkening, the screen turns off. The camera turns off after approximately three minutes of inactivity.

2 Shoot.

- To activate the screen and prepare for shooting when the screen is off but the lens is still out, press the shutter button halfway.

Power-Saving Adjustment

Adjust the timing of automatic camera and screen deactivation (Auto Power Down and Display Off, respectively) as needed (39).

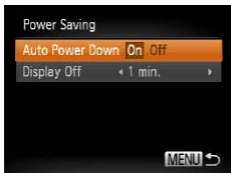

- Choose [Power Saving], and then press the <> button.
- After choosing an item, press the <◀>▶> buttons to adjust it as needed.



- To conserve battery power, you should normally choose [On] for [Auto Power Down] and [1 min.] or less for [Display Off].



- The [Display Off] setting is applied even if you set [Auto Power Down] to [Off].
- These power-saving functions are not available when you have set Eco mode (173) to [On].

Screen Brightness

Adjust screen brightness as follows.



- Choose [LCD Brightness], and then press the <◀>>> buttons to adjust the brightness.



- For maximum brightness, press and hold the <DISP.> button for at least one second when the shooting screen is displayed or when in single-image display. (This will override the [LCD Brightness] setting on the [Y/T] tab.) To restore the original brightness, press and hold the <DISP.> button again for at least one second or restart the camera.

Hiding the Start-Up Screen

If you prefer, you can deactivate display of the start-up screen normally shown when you turn the camera on.



- Choose [Start-up Image], and then choose [Off].

Formatting Memory Cards

Before using a new memory card or a card formatted in another device, you should format the card with this camera.

Formatting erases all data on a memory card. Before formatting, copy images on the memory card to a computer, or take other steps to back them up.



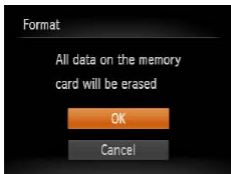
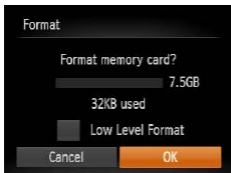



An Eye-Fi card (📖216) contains software on the card itself. Before formatting an Eye-Fi card, install the software on a computer.







1 Access the [Format] screen.

- Choose [Format], and then press the  button.

2 Choose [OK].

- Press the   buttons to choose [Cancel], choose [OK] (either press the   buttons or turn the  dial), and then press the  button.

3 Format the memory card.

- To begin the formatting process, press the   buttons or turn the  dial to choose [OK], and then press the  button.

- When formatting is finished, [Memory card formatting complete] is displayed. Press the  button.



- Formatting or erasing data on a memory card only changes file management information on the card and does not erase the data completely. When transferring or disposing of memory cards, take steps to protect personal information if necessary, as by physically destroying cards.



- The total card capacity indicated on the formatting screen may be less than the advertised capacity.

■ Low-Level Formatting

Perform low-level formatting in these cases: [Memory card error] is displayed, the camera is not working correctly, card image reading/writing is slower, continuous shooting is slower, or movie recording suddenly stops. Low-level formatting erases all data on a memory card. Before low-level formatting, copy images on the memory card to a computer, or take other steps to back them up.

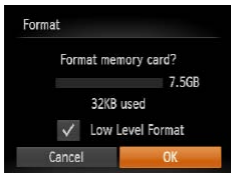

- On the screen in step 1 of “Formatting Memory Cards” (📖176), press the <▲><▼> buttons or turn the <⊙> dial to choose [Low Level Format], and then press the <◀><▶> buttons to select this option. A [✓] icon is displayed.
- Follow steps 2 – 3 in “Formatting Memory Cards” (📖176) to continue with the formatting process.



- Low-level formatting takes longer than “Formatting Memory Cards” (📖176), because data is erased from all storage regions of the memory card.
- You can cancel low-level formatting in progress by choosing [Stop]. In this case, all data will be erased, but the memory card can be used normally.

File Numbering

Your shots are automatically numbered in sequential order (0001 – 9999) and saved in folders that store up to 2,000 images each. You can change how the camera assigns file numbers.



- Choose [File Numbering], and then choose an option.

Continuous	Images are numbered consecutively (until the 9999th shot is taken/saved) even if you switch memory cards.
Auto Reset	Image numbering is reset to 0001 if you switch memory cards, or when a new folder is created.



- Regardless of the option selected in this setting, shots may be numbered consecutively after the last number of existing images on newly inserted memory cards. To start saving shots from 0001, use an empty (or formatted (📖176)) memory card.
- Refer to “Software Instruction Manual” (📖193) for information on the card folder structure and image formats.

Date-Based Image Storage

Instead of saving images in folders created each month, you can have the camera create folders each day you shoot to store shots taken that day.



- Choose [Create Folder], and then choose [Daily].
- Images will now be saved in folders created on the shooting date.

Metric / Non-Metric Display

Change the unit of measurement shown in the zoom bar (📖51), the MF indicator (📖108), and elsewhere from m/cm to ft/in as needed.

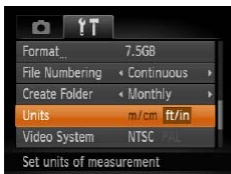

- Choose [Units], and then choose [ft/in].

Checking Certification Logos

Some logos for certification requirements met by the camera can be viewed on the screen. Other certification logos are printed in this guide, on the camera packaging, or on the camera body.

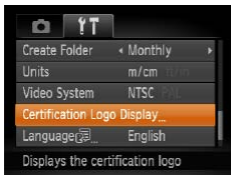









- Choose [Certification Logo Display], and then press the  button.

Display Language

Change the display language as needed.



- Choose [Language , and then press the  button.
- Press the     buttons or turn the  dial to choose a language, and then press the  button.



- You can also access the [Language] screen in Playback mode by pressing and holding the  button and immediately pressing the **<MENU>** button.

Adjusting Other Settings

The following settings can also be adjusted on the [Y/T] tab.

- [Video System] (📖190)
- [Eye-Fi Settings] (📖216)

Restoring Defaults

If you accidentally change a setting, you can restore default camera settings.

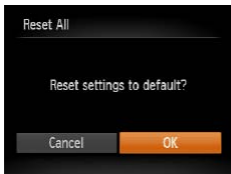

1 Access the [Reset All] screen.

- Choose [Reset All], and then press the <FUNC SET> button.

2 Restore default settings.

- Press the <◀▶> buttons or turn the <DIAL> dial to choose [OK], and then press the <FUNC SET> button.
- Default settings are now restored.



- The following functions are not restored to default settings.
 - [Y/T] tab settings [Date/Time] (📖170), [Language] (📖181), [Time Zone] (📖171), and [Video System] (📖190)
 - Custom white balance data you have recorded (📖102)
 - Shooting mode chosen in [SCN] (📖80) or [M] (📖84) mode

8

Accessories

Enjoy the camera in more ways with optional Canon accessories and other compatible accessories sold separately

System Map.....	184
Optional Accessories	186
Using Optional Accessories	189
Using the Software	193
Printing Images.....	199
Using an Eye-Fi Card	216

System Map

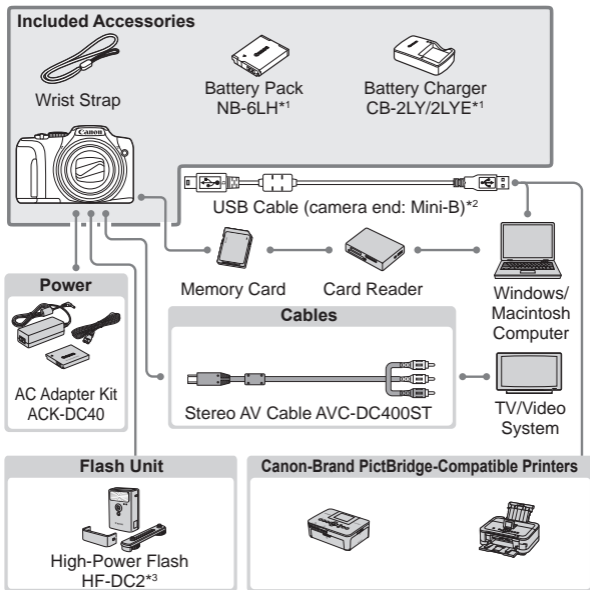

*1 Also available for purchase separately.

*2 A genuine Canon accessory is also available (Interface Cable IFC-400PCU).

*3 High-Power Flash HF-DC1 also supported.

Use of genuine Canon accessories is recommended.

This product is designed to achieve excellent performance when used with genuine Canon accessories.

Canon shall not be liable for any damage to this product and/or accidents such as fire, etc., caused by the malfunction of non-genuine Canon accessories (e.g., a leakage and/or explosion of a battery pack). Please note that this warranty does not apply to repairs arising out of the malfunction of non-genuine Canon accessories, although you may request such repairs on a chargeable basis.

Note that availability varies by area, and some accessories may no longer be available.

Optional Accessories

The following camera accessories are sold separately. Note that availability varies by area, and some accessories may no longer be available.

Power Supplies

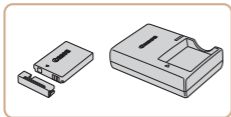

Battery Pack NB-6LH

- Rechargeable lithium-ion battery

Battery Charger CB-2LY/ CB-2LYE

- Charger for Battery Pack NB-6LH

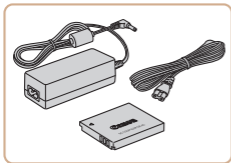

AC Adapter Kit ACK-DC40

- For powering the camera using household power. Recommended when using the camera over extended periods, or when connecting the camera to a printer or computer. Cannot be used to charge the battery pack in the camera.



- The battery charger and AC adapter kit can be used in areas with 100 – 240 V AC power (50/60 Hz).
- For power outlets in a different format, use a commercially available adapter for the plug. Never use an electrical transformer designed for traveling, which may damage the battery pack.



- The battery pack includes a convenient cover which you can attach to know the charging status at a glance. Attach the cover so that ▲ is visible on a charged battery pack, and attach it so that ▲ is not visible on an uncharged battery pack.
- Battery Pack NB-6L is also supported.

Flash Unit



High-Power Flash HF-DC2

- External flash for illuminating subjects that are out of range of the built-in flash.
High-Power Flash HF-DC1 can also be used.

Other Accessories

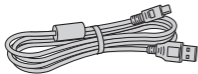

Interface Cable IFC-400PCU

- For connecting the camera to a computer or printer.

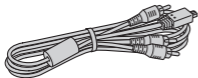

Stereo AV Cable AVC-DC400ST

- Connect the camera to a TV to enjoy playback on the larger TV screen.

Printers

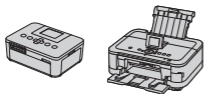

Canon-Brand PictBridge-Compatible Printers

- Printing images without a computer is possible by connecting the camera to a Canon-brand PictBridge-compatible printer.
For details, visit your nearest Canon retailer.

Using Optional Accessories

Playback on a TV

Connecting the camera to a TV with the Stereo AV Cable AVC-DC400ST (sold separately) enables you to view your shots on the larger screen of the TV as you control the camera.

For details on connection or how to switch inputs, refer to the TV manual.



- Some information may not be displayed on the TV (📖231).

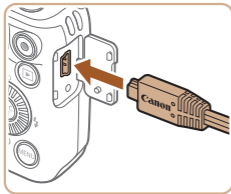
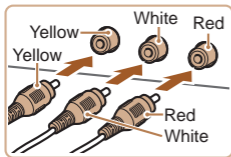

1 Make sure the camera and TV are off.

2 Connect the camera to the TV.

- On the TV, insert the cable plugs fully into the video inputs as shown.
- On the camera, open the terminal cover and insert the cable plug fully into the camera terminal.



3 Turn the TV on and switch to video input.

- Switch the TV input to the video input you connected the cable to in step 2.

4 Turn the camera on.

- Press the <▶> button to turn the camera on.
- Images from the camera are now displayed on the TV. (Nothing is displayed on the camera screen.)
- When finished, turn off the camera and TV before disconnecting the cable.



- Correct display is not possible unless the camera video output format (NTSC or PAL) matches the TV format. To change the video output format, press the <MENU> button and choose [Video System] on the [Y/T] tab.

Powering the Camera with Household Power

Powering the camera with AC Adapter Kit ACK-DC40 (sold separately) eliminates the need to monitor the remaining battery level.

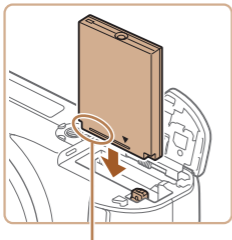

Terminals

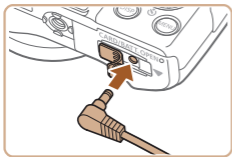

1 Make sure the camera is off.

2 Insert the coupler.

- Follow step 2 in “Inserting the Battery Pack and Memory Card” (📖24) to open the cover.
- Insert the coupler facing the direction shown, just as you would a battery pack (following step 3 in “Inserting the Battery Pack and Memory Card” (📖24)).
- Follow step 5 in “Inserting the Battery Pack and Memory Card” (📖25) to close the cover.

3 Connect the adapter to the camera.

- Open the cover and insert the adapter plug fully into the camera.

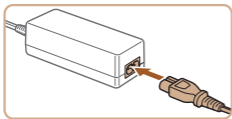

4 Connect the power cord.

- Insert one end of the power cord into the compact power adapter, and then plug the other end into a power outlet.
- Turn the camera on and use it as desired.
- When finished, turn the camera off and unplug the power cord from the outlet.



- Do not disconnect the adapter or unplug the power cord while the camera is still on. This may erase your shots or damage the camera.
- Do not attach the adapter or adapter cord to other objects. Doing so could result in malfunction or damage to the product.

Using the Software

The software available for download from the Canon website is introduced below, with instructions for installation and saving images to a computer.

Software

After downloading the software from the Canon website and installing it, you can do the following things on your computer.

CameraWindow

- Import images and change camera settings

ImageBrowser EX

- Manage images: view, search, and organize
- Print and edit images



- Internet access is required, and any ISP account charges and access fees must be paid separately.

Software Instruction Manual

Refer to the instruction manual when using the software. The manual can be accessed from the help system of software (some software excluded).

Checking Your Computer Environment

The software can be used on the following computers. For detailed system requirements and compatibility information, including support in new operating systems, visit the Canon website.

	Windows	Macintosh
Operating System	Windows 8 Windows 7 SP1 Windows Vista SP2 Windows XP SP3	Mac OS X 10.6 Mac OS X 10.7 Mac OS X 10.8



- Check the Canon website for the latest system requirements, including supported OS versions.

Installing the Software

Windows 7 and Mac OS X 10.6 are used here for the sake of illustration.

1 Download the software.

- With a computer connected to the Internet, access <http://www.canon.com/icpd/>.
- Access the site for your country or region.
- Download the software.



2 Install the software.

- Click [Easy Installation] and follow the on-screen instructions to complete the installation process.
- Installation may take some time, depending on computer performance and the Internet connection.
- Click [Finish] or [Restart] on the screen after installation.



- Using the software, you can update to the latest version, and download new functions via the Internet (some software excluded).
- The first time you connect the camera to the computer, drivers will be installed, so it may take a few minutes until camera images are accessible.

Saving Images to a Computer

Windows 7 and Mac OS X 10.6 are used here for the sake of illustration.

For other functions, refer to the help system of the relevant software (some software excluded).

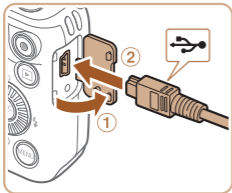

1 Connect the camera to the computer.

- With the camera turned off, open the cover (①). With the smaller plug of the USB cable in the orientation shown, insert the plug fully into the camera terminal (②).

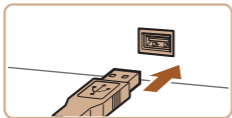

- Insert the larger plug of the USB cable in the computer's USB port. For details about USB connections on the computer, refer to the computer user manual.



2 Turn the camera on to access CameraWindow.

- Press the <▶> button to turn the camera on.
- On a Macintosh computer, CameraWindow is displayed when a connection is established between the camera and computer.

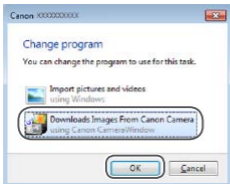

CameraWindow



- For Windows, follow the steps introduced below.
- In the screen that displays, click the [] link to modify the program.
- Choose [Downloads Images From Canon Camera] and then click [OK].

- Double-click [].

3 Save the images to the computer.

- Click [Import Images from Camera], and then click [Import Untransferred Images].
- Images are now saved to the Pictures folder on the computer, in separate folders named by date.

- After images are saved, close CameraWindow, press the <▶> button to turn the camera off, and unplug the cable.
- For instructions on viewing images on a computer, refer to “Software Instruction Manual” (📖193).



- In Windows 7, if the screen in step 2 is not displayed, click the [📷] icon in the taskbar.
- To start CameraWindow in Windows Vista or XP, click [Downloads Images From Canon Camera] on the screen displayed when you turn the camera on in step 2. If CameraWindow is not displayed, click the [Start] menu and choose [All Programs] ▶ [Canon Utilities] ▶ [CameraWindow] ▶ [CameraWindow].
- On a Macintosh computer, if CameraWindow is not displayed after step 2, click the [CameraWindow] icon in the Dock (the bar at the bottom of the desktop).
- Although you can save images to a computer simply by connecting your camera to the computer without using the software, the following limitations apply.
 - It may take a few minutes after you connect the camera to the computer until camera images are accessible.
 - Images shot in vertical orientation may be saved in horizontal orientation.
 - Image protection settings may be cleared from images saved to a computer.
 - Some problems may occur when saving images or image information, depending on the operating system version, the software in use, or image file sizes.
 - Some functions provided by the software may not be available, such as movie editing.

Printing Images

Your shots can easily be printed by connecting the camera to a printer. On the camera, you can specify images to set up batch printing, prepare orders for photo development services, and prepare orders or print images for photobooks.

A Canon SELPHY CP series compact photo printer is used here for the sake of illustration. Screens displayed and available functions vary by printer. Also refer to the printer manual for additional information.

Easy Print

Easily print your shots by connecting the camera to a PictBridge-compatible printer (sold separately) with the USB cable.

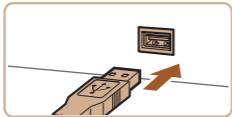
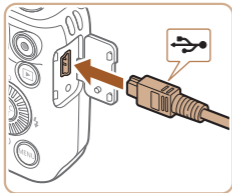

1 Make sure the camera and printer are off.

2 Connect the camera to the printer.

- Open the cover. Holding the smaller cable plug in the orientation shown, insert the plug fully into the camera terminal.
- Connect the larger cable plug to the printer. For other connection details, refer to the printer manual.



3 Turn the printer on.

4 Turn the camera on.

- Press the <▶> button to turn the camera on.

5 Choose an image.

- Press the <◀><▶> buttons or turn the <◉> dial to choose an image.

6 Access the printing screen.

- Press the <FUNC SET> button, choose [Print], and press the <FUNC SET> button again.



7 Print the image.

- Press the <▲><▼> buttons or turn the <◉> dial to choose [Print], and then press the <FUNC SET> button.
- Printing now begins.
- To print other images, repeat the above procedures starting from step 5 after printing is finished.
- When you are finished printing, turn the camera and printer off and disconnect the cable.

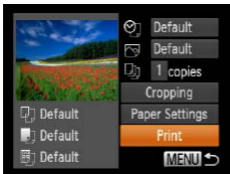



- For Canon-brand PictBridge-compatible printers (sold separately), see “Printers” (📖188).

Still Images

Configuring Print Settings

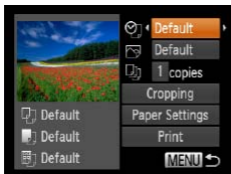

1 Access the printing screen.

- Follow steps 1 – 6 in “Easy Print” (📖199 – 200) to access the screen at left.

2 Configure the settings.

- Press the <▲><▼> buttons or turn the <⦿> dial to choose an item, and then choose an option by pressing the <◀><▶> buttons.

🗨️	Default	Matches current printer settings.
	Date	Prints images with the date added.
	File No.	Prints images with the file number added.
	Both	Prints images with both the date and file number added.
	Off	–
📧	Default	Matches current printer settings.
	Off	–
	On	Uses information from the time of shooting to print under optimal settings.
	Red-Eye 1	Corrects red-eye.
📄	No. of Copies	Choose the number of copies to print.

Cropping	–	Specify a desired image area to print (📖202).
Paper Settings	–	Specify the paper size, layout, and other details (📖203).

Still Images

Cropping Images before Printing

By cropping images before printing, you can print a desired image area instead of the entire image.

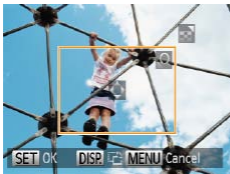

1 Choose [Cropping].

- After following step 1 in “Configuring Print Settings” (📖201) to access the printing screen, choose [Cropping] and press the <FUNC-SET> button.
- A cropping frame is now displayed, indicating the image area to print.

2 Adjust the cropping frame as needed.

- To resize the frame, move the zoom lever or turn the <ZOOM> dial.
- To move the frame, press the <▲><▼><◀><▶> buttons.
- To rotate the frame, press the <DISP.> button.
- When finished, press the <FUNC-SET> button.

3 Print the image.

- Follow step 7 in “Easy Print” (📖200) to print.



- Cropping may not be possible at small image sizes, or at some aspect ratios.
- Dates may not be printed correctly if you crop images shot with [Date Stamp 

Still Images

Choosing Paper Size and Layout before Printing

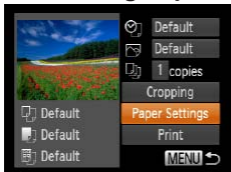

1 Choose [Paper Settings].

- After following step 1 in “Configuring Print Settings” (📖201) to access the printing screen, choose [Paper Settings] and press the <FUNC SET> button.

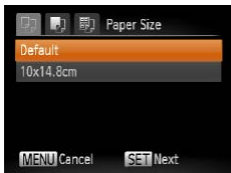

2 Choose a paper size.

- Press the <▲><▼> buttons or turn the <🌀> dial to choose an option, and then press the <FUNC SET> button.

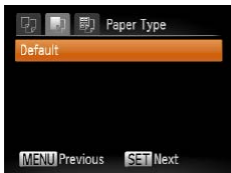

3 Choose a type of paper.

- Press the <▲><▼> buttons or turn the <⊙> dial to choose an option, and then press the <FUNC SET> button.



4 Choose a layout.

- Press the <▲><▼> buttons or turn the <⊙> dial to choose an option.
- When choosing [N-up], press the <◀><▶> buttons to specify the number of images per sheet.
- Press the <FUNC SET> button.

5 Print the image.

Available Layout Options

Default	Matches current printer settings.
Bordered	Prints with blank space around the image.
Borderless	Borderless, edge-to-edge printing.
N-up	Choose how many images to print per sheet.
ID Photo	Prints images for identification purposes. Only available for images with a resolution of L and an aspect ratio of 4:3.
Fixed Size	Choose the print size. Choose from 3.5 x 5 in., postcard, or wide-format prints.

■ Printing ID Photos



1 Choose [ID Photo].

- Following steps 1 – 4 in “Choosing Paper Size and Layout before Printing” (📖203 – 204), choose [ID Photo] and press the button.

2 Choose the long and short side length.

- Press the or turn the dial to choose an item. Choose the length by pressing the , and then press the button.

3 Choose the printing area.

- Follow step 2 in “Cropping Images before Printing” (📖202) to choose the printing area.

4 Print the image.

Printing Movie Scenes

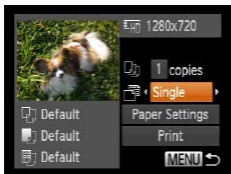

1 Access the printing screen.

- Follow steps 1 – 6 in “Easy Print” (📖 199 – 200) to choose a movie. The screen at left is displayed.
- Press the <◀><▶> buttons or turn the <⊙> dial to choose [📄], and then press the <FUNC SET> button. The screen at left is displayed.

2 Choose a printing method.

- Press the <▲><▼> buttons or turn the <⊙> dial to choose [📄], and then press the <◀><▶> buttons to choose the printing method.

3 Print the image.

Movie Printing Options

Single	Prints the current scene as a still image.
Sequence	Prints a series of scenes, a certain interval apart, on a single sheet of paper. You can also print the folder number, file number, and elapsed time for the frame by setting [Caption] to [On].



- To cancel printing in progress, press the  button.
- [ID Photo] and [Sequence] cannot be chosen on Canon-brand PictBridge-compatible printers from CP720/CP730 and earlier models.

Still Images

Adding Images to the Print List (DPOF)



Batch printing ( 212) and ordering prints from a photo development service can be set up on the camera. Choose up to 998 images on a memory card and configure relevant settings, such as the number of copies, as follows. The printing information you prepare this way will conform to DPOF (Digital Print Order Format) standards.

Still Images

Configuring Print Settings

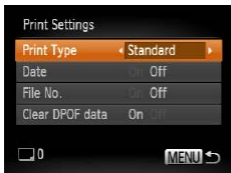
Specify the printing format, whether to add the date or file number, and other settings as follows. These settings apply to all images in the print list.



- Press the **<MENU>** button, and then choose [Print Settings] on the  tab. Choose and configure items as desired ( 45).

Print Type	Standard	One image is printed per sheet.
	Index	Smaller versions of multiple images are printed per sheet.
	Both	Both standard and index formats are printed.
Date	On	Images are printed with the shooting date.
	Off	–
File No.	On	Images are printed with the file number.
	Off	–
Clear DPOF data	On	All image print list settings are cleared after printing.
	Off	–



- Not all of your DPOF settings may be applied in printing by the printer or photo development service, in some cases.
- [!] may be displayed on the camera to warn you that the memory card has print settings that were configured on another camera. Changing the print settings using this camera may overwrite all previous settings.
- Setting [Date] to [On] may cause some printers to print the date twice.



- Specifying [Index] will prevent you from choosing [On] for both [Date] and [File No.] at the same time.
- The date is printed in a format matching setting details in [Date/Time] on the [↑↑] tab, accessible by pressing the <MENU> button (📖26).
- Index printing is not available on some Canon-brand PictBridge-compatible printers (sold separately).

Setting Up Printing for Individual Images

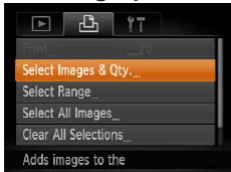

1 Choose [Select Images & Qty.].

- Press the <MENU> button, choose [Select Images & Qty.] on the [P] tab, and then press the <FUNC/SET> button.

2 Choose an image.

- Press the <◀><▶> buttons or turn the <DIAL> dial to choose an image, and then press the <FUNC/SET> button.
- You can now specify the number of copies.
- If you specify index printing for the image, it is labeled with a [✓] icon. To cancel index printing for the image, press the <FUNC/SET> button again. [✓] is no longer displayed.



3 Specify the number of prints.

- Press the <▲><▼> buttons or turn the <⦿> dial to specify the number of prints (up to 99).
- To set up printing for other images and specify the number of prints, repeat steps 2 – 3.
- Printing quantity cannot be specified for index prints. You can only choose which images to print, by following step 2.
- When finished, press the <MENU> button to return to the menu screen.

Still Images

Setting Up Printing for a Range of Images



- Following step 1 in “Setting Up Printing for Individual Images” (📖209), choose [Select Range] and press the <FUNC SET> button.
- Follow steps 2 – 3 in “Selecting a Range” (📖146) to specify images.
- Press the <▲><▼> buttons to choose [Order], and then press the <FUNC SET> button.

Setting Up Printing for All Images

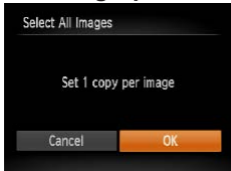

- Following step 1 in “Setting Up Printing for Individual Images” (📖209), choose [Select All Images] and press the <FUNC SET> button.
- Press the <◀>>▶> buttons or turn the <⚙️> dial to choose [OK], and then press the <FUNC SET> button.

Clearing All Images from the Print List

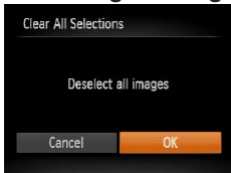

- Following step 1 in “Setting Up Printing for Individual Images” (📖209), choose [Clear All Selections] and press the <FUNC SET> button.
- Press the <◀>>▶> buttons or turn the <⚙️> dial to choose [OK], and then press the <FUNC SET> button.

Printing Images Added to the Print List (DPOF)



- When images have been added to the print list (📖207 – 211), the screen at left is displayed after you connect the camera to a PictBridge-compatible printer. Press the <▲><▼> buttons to choose [Print now], and then simply press the <FUNC SET> button to print the images in the print list.
- Any DPOF print job that you temporarily stop will be resumed from the next image.

Adding Images to a Photobook

Photobooks can be set up on the camera by choosing up to 998 images on a memory card and importing them into the software on your computer, where they are stored in their own folder. This is convenient when ordering printed photobooks online or printing photobooks with your own printer.

Choosing a Selection Method

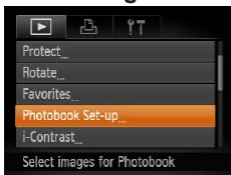

- Press the <MENU> button, choose [Photobook Set-up] on the [▶] tab, and then choose how you will select images.



- [!] may be displayed on the camera to warn you that the memory card has print settings that were configured on another camera. Changing the print settings using this camera may overwrite all previous settings.



- After importing images to your computer, also refer to “Software Instruction Manual” (📖193) and the printer manual for further information.

Adding Images Individually



1 Choose [Select].

- Following the procedure in “Choosing a Selection Method” (213), choose [Select] and press the <FUNC SET> button.

2 Choose an image.

- Press the <◀>> buttons or turn the <◉> dial to choose an image, and then press the <FUNC SET> button.
- [✓] is displayed.
- To remove the image from the photobook, press the <FUNC SET> button again. [✓] is no longer displayed.
- Repeat this process to specify other images.
- When finished, press the <MENU> button to return to the menu screen.

Adding All Images to a Photobook

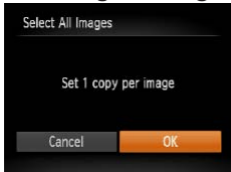

- Following the procedure in “Choosing a Selection Method” (📖214), choose [Select All Images] and press the <FUNC SET> button.
- Press the <<>>> buttons or turn the <⚙> dial to choose [OK], and then press the <FUNC SET> button.

Removing All Images from a Photobook

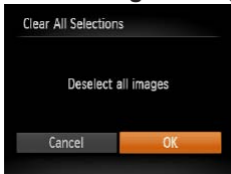

- Following the procedure in “Choosing a Selection Method” (📖214), choose [Clear All Selections] and press the <FUNC SET> button.
- Press the <<>>> buttons or turn the <⚙> dial to choose [OK], and then press the <FUNC SET> button.

Using an Eye-Fi Card

Before using an Eye-Fi card, always confirm that local use is permitted (📖3).





Inserting a prepared Eye-Fi card enables automatic wireless transfer of images to a computer or uploading to a photo-sharing website.

Images are transferred by the Eye-Fi card. Refer to the card's user manual or contact the manufacturer for instructions on preparing and using cards or resolving transfer problems.



- When using an Eye-Fi card, keep the following points in mind.
 - Cards may continue to transmit radio waves even when [Eye-Fi trans.] is set to [Disable] (📖218). Remove the Eye-Fi card before entering hospitals, aircraft, or other areas where transmission is prohibited.
 - When troubleshooting image transfer issues, check the card and computer settings. For details, refer to the card's user manual.
 - Poor Eye-Fi connections may cause image transfer to take a long time, and transfer may be interrupted in some cases.
 - Eye-Fi cards may become hot, due to their transfer functions.
 - Battery power will be consumed faster than in normal use.
 - Camera operation may become sluggish. To resolve this, try setting [Eye-Fi trans.] to [Disable].

Connection status of Eye-Fi cards in the camera can be checked on the shooting screen (in regular information display mode) or playback screen (in simple information display mode).

 (Gray)	Not connected	 Interrupted
 (Blinking white)	Connecting	 Not communicating
 (White)	Connected	 Error acquiring Eye-Fi card information*2
 (Animated)	Transfer in progress*1	

*1 Power saving (📖39) on the camera is temporarily disabled during image transfer.



*2 Restart the camera. Repeated display of this icon may indicate a problem with the card.

Images labeled with a [] icon have been transferred.

Checking Connection Information

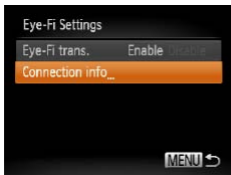
Check the access point SSID used by the Eye-Fi card or the connection status, as needed.



- Press the <MENU> button, choose [Eye-Fi Settings] on the [] tab, and then press the <> button.
- Choose [Connection info], and then press the <> button.
- The connection information screen is displayed.

Disabling Eye-Fi Transfer

Configure the setting as follows to disable Eye-Fi transfer by the card, if necessary.

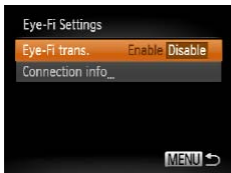

Choose [Disable] in [Eye-Fi trans.].

- Press the <MENU> button, choose [Eye-Fi Settings] on the [↑] tab, and then press the <FUNC/SET> button.
- Choose [Eye-Fi trans.], and then choose [Disable].



- [Eye-Fi Settings] is not shown unless an Eye-Fi card is in the camera with its write-protect tab in the unlocked position. For this reason, you cannot change settings for an inserted Eye-Fi card if the write-protect tab is in the locked position.

9

Appendix

Helpful information when using the camera

Troubleshooting	220	Handling Precautions.....	255
On-Screen Messages	226	Specifications	256
On-Screen Information.....	229		
Functions and Menu			
Tables	233		

Troubleshooting

If you think there is a problem with the camera, first check the following. If the items below do not solve your problem, contact a Canon Customer Support Help Desk.

Power

Nothing happens when the power button is pressed.

- Confirm that the battery pack is charged (📖21).
- Confirm that the battery pack is inserted facing the correct way (📖24).
- Confirm that the memory card/battery cover is fully closed (📖25).
- Dirty battery terminals reduce battery performance. Try cleaning the terminals with a cotton swab and reinserting the battery pack a few times.

The battery pack runs out of power quickly.

- Battery performance decreases at low temperatures. Try warming the battery pack a little by putting it in your pocket, for example, ensuring that the terminals do not touch any metal objects.
- If these measures do not help and the battery pack still runs out of power soon after charging, it has reached the end of its life. Purchase a new battery pack.

The lens is not retracted.

- Do not open the memory card/battery cover while the camera is on. Close the cover, turn the camera on, and then turn it off again (📖25).

The battery pack is swollen.

- Battery swelling is normal and does not pose any safety concerns. However, if battery swelling prevents the battery pack from fitting in the camera, contact a Canon Customer Support Help Desk.

Display on a TV

Camera images look distorted or not displayed on a TV (📖189).

Shooting

Cannot shoot.

- In Playback mode (📖129), press the shutter button halfway (📖40).

Strange display on the screen under low light (📖42).

Strange display on the screen when shooting.

Note that the following display problems are not recorded in still images but are recorded in movies.

- The screen may darken under bright light.
- The screen may flicker under fluorescent or LED lighting.
- Purplish banding may appear on the screen if you compose a shot that includes a bright light source.

No date stamp is added to images.

- Configure the [Date Stamp ] setting (📖26). Note that date stamps are not added to images automatically, merely because you have configured the [Date/Time] setting (📖64).
- Date stamps are not added in shooting modes (📖251) in which this setting cannot be configured (📖64).

flashes on the screen when the shutter button is pressed, and shooting is not possible (📖54).

is displayed when the shutter button is pressed halfway (📖54).

- Set [IS Mode] to [Continuous] (📖122).
- Raise the flash and set the flash mode to [] (📖117).
- Increase the ISO speed (📖99).
- Mount the camera on a tripod or take other measures to keep it still. In this case, you should set [IS Mode] to [Off] (📖122).

Shots are out of focus.

- Press the shutter button halfway to focus on subjects before pressing it all the way down to shoot (📖40).
- Make sure subjects are within focusing range (📖259).
- Set [AF-assist Beam] to [On] (📖74).
- Confirm that unneeded functions such as macro are deactivated.
- Try shooting with focus lock or AF lock (📖111, 116).

No AF frames are displayed and the camera does not focus when the shutter button is pressed halfway.

- To have AF frames displayed and the camera focus correctly, try composing the shot with higher-contrast subject areas centered before you press the shutter button halfway. Otherwise, try pressing the shutter button halfway repeatedly.

Subjects in shots look too dark.

- Raise the flash and set the flash mode to [⚡] (📖117).
- Adjust brightness by using exposure compensation (📖96).
- Adjust contrast by using i-Contrast (📖100, 162).
- Use AE lock or spot metering (📖97, 98).

Subjects look too bright, highlights are washed-out.

- Lower the flash and set the flash mode to [☀] (📖51).
- Adjust brightness by using exposure compensation (📖96).
- Use AE lock or spot metering (📖97, 98).
- Reduce the lighting on subjects.

Shots look too dark despite the flash firing (📖54).

- Shoot within flash range (📖258).
- Adjust brightness by using flash exposure compensation or changing the flash output level (📖119, 128).
- Increase the ISO speed (📖99).

Subjects in flash shots look too bright, highlights are washed-out.

- Shoot within flash range (📖258).
- Lower the flash and set the flash mode to [☺] (📖51).
- Adjust brightness by using flash exposure compensation or changing the flash output level (📖119, 128).

White dots or similar image artifacts appear in flash shots.

- This is caused by light from the flash reflecting off dust or airborne particles.

Shots look grainy.

- Lower the ISO speed (📖99).

Subjects are affected by red-eye (📖68).

- Set [Red-Eye Lamp] to [On] (📖75) to activate the red-eye reduction lamp (📖5) in flash shots. Note that while the red-eye reduction lamp is on (for about one second), it is not possible to shoot, because the lamp is counteracting red-eye. For best results, have subjects look at the red-eye reduction lamp. Also try increasing the lighting in indoor scenes and shooting at closer range.
- Edit images using red-eye correction (📖163).

Recording to the memory card takes too long, or continuous shooting is slower.

- Use the camera to perform low-level formatting of the memory card (📖178).

Shooting settings or FUNC. menu settings are not available.

- Available setting items vary by shooting mode. Refer to “Functions Available in Each Shooting Mode”, “FUNC. Menu”, and “Shooting Tab Menu” (📖233 – 252).

Shooting Movies

The elapsed time shown is incorrect, or recording is interrupted.

- Use the camera to format the memory card, or switch to a card that supports high-speed recording. Note that even if the elapsed time display is incorrect, the length of movies on the memory card corresponds to the actual recording time (📖176, 258).

[❗] is displayed and shooting stops automatically.

The camera's internal memory buffer filled up as the camera could not record to the memory card quickly enough. Try one of the following measures.

- Use the camera to perform low-level formatting of the memory card (📖178).
- Lower the image quality (📖69).
- Switch to a memory card that supports high-speed recording (📖258).

Zooming is not possible.

- Zooming is not possible when shooting movies in [📷] mode (📖87).

Playback

Playback is not possible.

- Image or movie playback may not be possible if a computer is used to rename files or alter the folder structure. Refer to “Software Instruction Manual” (📖193) for details on folder structure and file names.

Playback stops, or audio skips.

- Switch to a memory card that you have performed low-level formatting on with the camera (📖178).
- There may be brief interruptions when playing movies copied to memory cards that have slow read speeds.
- When movies are played on a computer, frames may be dropped and audio may skip if computer performance is inadequate.

Sound is not played during movies.

- Adjust the volume (📖132) if you have activated [Mute] (📖169) or the sound in the movie is faint.
 - No sound is played for movies shot in [📷] mode (📖87) because audio is not recorded in this mode.
-

Memory Card**The memory card is not recognized.**

- Restart the camera, with the memory card in it (📖38).
-

Computer**Cannot transfer images to a computer.**

When attempting to transfer images to the computer via a cable, try reducing the transfer speed as follows.

- Press the <▶> button to enter Playback mode. Hold the <MENU> button down as you press the <▲> and <FUNC SET> buttons at the same time. On the next screen, press the <◀><▶> buttons to choose [B], and then press the <FUNC SET> button.
-

Eye-Fi Cards**Cannot transfer images (📖216).**

On-Screen Messages

If an error message is displayed, respond as follows.

No memory card

- The memory card may be inserted facing the wrong way. Reinsert the memory card facing the correct way (📖24).

Memory card locked

- The write-protect tab of the memory card is set to the locked position. Switch the write-protect tab to the unlocked position (📖23).

Cannot record!

- Shooting was attempted without a memory card in the camera. To shoot, insert a memory card facing the correct way (📖24).

Memory card error (📖178)

- If the same error message is displayed even after you have formatted a supported memory card (📖3) and have inserted it facing the correct way (📖24), contact a Canon Customer Support Help Desk.

Insufficient space on card

- There is not enough free space on the memory card to shoot (📖50, 78, 94, 123) or edit images (📖157 – 163). Either erase unneeded images (📖149) or insert a memory card with enough free space (📖23).

Charge the battery (📖21)

No Image.

- The memory card does not contain any images that can be displayed.

Protected! (📖143)

Unidentified Image/Incompatible JPEG/Image too large./ Cannot play back MOV/Cannot play back MP4

- Unsupported or corrupt images cannot be displayed.
- It may not be possible to display images that were edited or renamed on a computer, or images shot with another camera.

Cannot magnify!/Cannot play back this content in Smart Shuffle/Cannot rotate/Cannot modify image/Cannot modify/ Cannot assign to category/Unselectable image.

- The following functions may be unavailable for images that were renamed or already edited on a computer, or images shot with another camera. Note that starred (*) functions are not available for movies. Magnify* (📖138), Smart Shuffle* (📖141), Rotate (📖153), Favorites (📖155), Edit* (📖157 – 164), Print List* (📖207), and Photobook Set-up* (📖213).

Invalid selection range

- When specifying a range for image selection (📖146, 152, 210), you attempted to choose an initial image that was after the final image, or vice-versa.

Exceeded selection limit

- More than 998 images were selected for Print List (📖207) or Photobook Set-up (📖213). Choose 998 images or less.
- Print List (📖207) or Photobook Set-up (📖213) settings could not be saved correctly. Reduce the number of selected images and try again.
- You attempted to choose more than 500 images in Protect (📖143), Erase (📖149), Favorites (📖155), Print List (📖207), or Photobook Set-up (📖213).

Communication error

- An excessive amount of images (approx. 1,000) on the memory card prevented printing or image transfer to a computer. To transfer the images, use a commercially available USB card reader. To print, insert the memory card directly into the printer card slot.

Naming error!

- The folder could not be created or images could not be recorded, because the highest supported folder number (999) for storing images on the card has been reached and the highest supported image number (9999) for images in folders has been reached. On the [📁] tab, change [File Numbering] to [Auto Reset] (📖179), or format the memory card (📖176).

Lens Error

- This error may occur if the lens is held while it is moving, or when the camera is used in dusty or sandy locations.
- Frequent display of this error message may indicate camera damage. In this case, contact a Canon Customer Support Help Desk.

A camera error was detected (*error number*)

- If this error message is displayed immediately after a shot, the image may not have been saved. Switch to Playback mode to check for the image.
- Frequent display of this error message may indicate camera damage. In this case, write down the error number (*Exx*) and contact a Canon Customer Support Help Desk.

File Error

- Correct printing ( 199) may not be possible for photos from other cameras or images that have been altered using computer software, even if the camera is connected to the printer.

Print error

- Check the paper size setting ( 203). If this error message is displayed when the setting is correct, restart the printer and complete the setting on the camera again.

Ink absorber full

- Contact a Canon Customer Support Help Desk to request assistance with ink absorber replacement.

On-Screen Information

Shooting (Information Display)

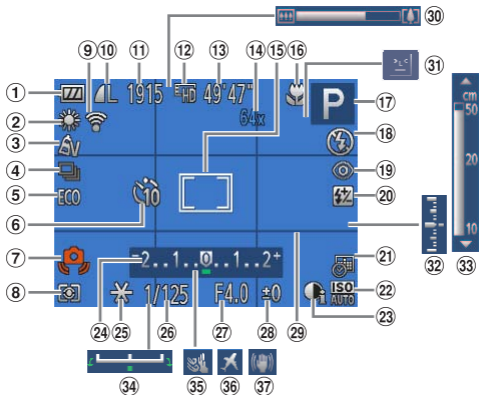



- | | | |
|--|--|---|
| ① Battery level
(230) | ⑦ Camera shake warning
(54) | ⑪ Still images:
Recordable shots
(257) |
| ② White balance
(101) | ⑧ Metering method
(98) | ⑫ Movie resolution
(69) |
| ③ My Colors
(103) | ⑨ Eye-Fi connection
status (216) | ⑬ Movies:
Remaining time
(258) |
| ④ Drive mode
(105) | ⑩ Still image
compression
(121),
Resolution
(67) | ⑭ Digital zoom
magnification
(59), Digital
tele-converter
(109) |
| ⑤ Eco mode
(173) | | |
| ⑥ Self-timer
(61) | | |

- 15 AF frame (📖110), Spot AE point frame (📖98)
- 16 Focusing range (📖107, 108), AF lock (📖116), IS mode icon (📖57)
- 17 Shooting mode (📖233), Scene icon (📖56)
- 18 Flash mode (📖117)
- 19 Red-eye correction (📖68)
- 20 Flash exposure compensation / Flash output level (📖119, 128)
- 21 Date stamp (📖64)
- 22 ISO speed (📖99)
- 23 i-Contrast (📖100)
- 24 Exposure compensation bar (📖96)
- 25 AE lock (📖97), FE lock (📖120)
- 26 Shutter speed (📖124, 126)
- 27 Aperture value (📖125, 126)
- 28 Exposure compensation level (📖96)
- 29 Grid lines (📖71)
- 30 Zoom bar (📖51)
- 31 Blink detection (📖73)
- 32 Exposure level (📖126)
- 33 MF indicator (📖108)
- 34 Exposure shift bar
- 35 Wind filter (📖70)
- 36 Time zone (📖171)
- 37 Image stabilization (📖122)

■ Battery Level

An on-screen icon or message indicates the battery charge level.

Display	Details
	Sufficient charge
	Slightly depleted, but sufficient
 (Blinking red)	Nearly depleted—charge the battery pack soon
[Charge the battery]	Depleted—charge the battery pack immediately

Playback (Detailed Information Display)

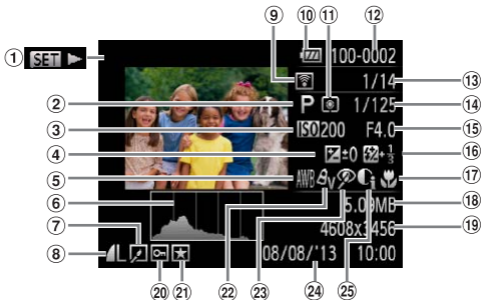

- | | | |
|---|---|---|
| ① Movies
(50 , 130) | ⑧ Compression
(image quality)
(121) /
Resolution
(67 , 69),
MOV (movies) | ⑭ Shutter speed
(still images)
(124), Image
quality / Frame
rate (movies)
(69) |
| ② Shooting mode
(233) | ⑨ Transferred via
Eye-Fi (216) | ⑮ Aperture value
(125 , 126),
Image quality
(movies) (69) |
| ③ ISO speed
(99),
Playback speed
(88) | ⑩ Battery level
(230) | ⑯ Flash (117),
Flash exposure
compensation
(119) |
| ④ Exposure
compensation
level (96),
Exposure shift
level (93) | ⑪ Metering method
(98) | ⑰ Focusing range
(107 , 108) |
| ⑤ White balance
(101) | ⑫ Folder number
- File number
(179) | ⑱ File size |
| ⑥ Histogram
(134) | ⑬ Current image
no. / Total no. of
images | |
| ⑦ Image editing
(157 - 164) | | |

- | | | |
|--|--|--|
| <p>19 Still images:
Resolution
(📖257)
Movies: Playback
time (📖258)</p> | <p>21 Favorites
(📖155)</p> <p>22 My Colors
(📖103, 161)</p> <p>23 Red-eye
correction
(📖68, 163)</p> | <p>24 Shooting date/
time (📖26)</p> <p>25 i-Contrast
(📖100, 162)</p> |
| <p>20 Protection
(📖143)</p> | | |



- Some information may not be displayed when viewing images on a TV (📖189).

■ Summary of Movie Control Panel in “Viewing” (📖130)

	Exit
	Play
	Slow Motion (To adjust the playback speed, press the <◀><▶> buttons or turn the dial. No sound is played.)
	Skip Backward* (To continue skipping backward, keep holding down the button.)
	Previous Frame (For fast-rewind, keep holding down the button.)
	Next Frame (For fast-forward, keep holding down the button.)
	Skip Forward* (To continue skipping forward, keep holding down the button.)
	Edit (📖165)
	Shown when the camera is connected to a PictBridge-compatible printer (📖199).

















* Displays the frame approx. 4 sec. before or after the current frame.



- To skip forward or back during movie playback, press the <◀><▶> buttons.

Functions and Menu Tables

Functions Available in Each Shooting Mode

Shooting Mode	M	Av	Tv	P	LIVE	AUTO
Function						
Exposure Compensation (📖96)	–	○	○	○	*1	–
ISO Speed (📖99)						
 AUTO	–	○	○	○	○	○
 100  200  400  800  1600	○	○	○	○	–	–
Focusing Range (📖107, 108, 116)						
 A	○	○	○	○	○	○
 / MF	○	○	○	○	○	–
Self-Timer (📖61)						
 Off	○	○	○	○	○	○
 10  2 	○	○	○	○	○	○
Self-Timer Settings (📖63)						
Delay*2	○	○	○	○	○	○
Shots*3	○	○	○	○	○	○
Flash (📖117)						
 A	–	–	–	○	○	○
	○	○	○	○	○	–
 *	–	○	–	○	○	*4
	–	–	–	–	–	–
Av/Tv Settings (📖124)						
Aperture Value	○	○	–	–	–	–
Shutter Speed	○	–	○	–	–	–
Program Shift (📖97)	–	○	○	○	–	–





















○ Available or set automatically. – Not available.

*1 Settings [Dark - Light] (📖79).

*2 Cannot be set to 0 seconds in modes without selection of the number of shots.

*3 One shot (cannot be modified) in modes without selection of the number of shots.

























*4 Not available, but switches to [ *] in some cases.

Function	SCN				
					
Shooting Mode					
Exposure Compensation (📖96)	○	○	○	○	○
ISO Speed (📖99)					
	○	○	○	○	○
    	–	–	–	–	–
Focusing Range (📖107, 108, 116)					
	○	○	○	○	○
 / MF	○	–	○	○	–
Self-Timer (📖61)					
	○	○	○	○	○
  	○	–	○	○	○
Self-Timer Settings (📖63)					
Delay*1	○	–	○	○	○
Shots*2	○	–	○	○	○
Flash (📖117)					
	○	○	○	○	–
	○	○	–	○	–
	–	–	–	–	–
	–	–	–	–	○
Av/Tv Settings (📖124)					
Aperture Value	–	–	–	–	–
Shutter Speed	–	–	–	–	–
Program Shift (📖97)	–	–	–	–	–

○ Available or set automatically. – Not available.

*1 Cannot be set to 0 seconds in modes without selection of the number of shots.

*2 One shot (cannot be modified) in modes without selection of the number of shots.

Function	Shooting Mode							
								
Exposure Compensation (📖96)	○	○	○	○	○	–	○	–
ISO Speed (📖99)								
	○	○	○	○	○	○	○	○
    	–	–	–	–	–	–	–	–
Focusing Range (📖107, 108, 116)								
	○	○	○	○	○	○	○	○
 / MF	○	○	○	○	○	○	○	○
Self-Timer (📖61)								
	○	○	○	○	○	○	○	○
  	○	○	○	○	○	○	–	○
Self-Timer Settings (📖63)								
Delay*1	○	○	○	○	○	○	–	○
Shots*2	○	○	○	○	○	○	–	–
Flash (📖117)								
	○	○	○	○	○	○	–	–
	○	○	○	○	○	○	–	–
	–	–	–	–	–	–	–	–
	–	–	–	–	–	–	○	○
Av/Tv Settings (📖124)								
Aperture Value	–	–	–	–	–	–	–	–
Shutter Speed	–	–	–	–	–	–	–	–
Program Shift (📖97)	–	–	–	–	–	–	–	–

○ Available or set automatically. – Not available.









*1 Cannot be set to 0 seconds in modes without selection of the number of shots.

*2 One shot (cannot be modified) in modes without selection of the number of shots.

Shooting Mode	M	Av	Tv	P	LIVE	AUTO
Function						
AE Lock/FE Lock*1 (📖97, 120)	–	○	○	○	–	–
AE Lock (Movie)/Exposure Shift (📖93)	–	–	–	–	–	–
Tracking AF	○	○	○	○	○	–
Screen Display (📖42)						
No Information Display	○	○	○	○	○	○
Information Display	○	○	○	○	○	○













○ Available or set automatically. – Not available.

*1 FE lock not available in [📷] flash mode.

Shooting Mode Function	SCN				
					
AE Lock/FE Lock*1 ( , 97, 120)	–	–	–	–	–
AE Lock (Movie)/Exposure Shift ( , 93)	–	–	–	–	–
Tracking AF	○	–	○	○	–
Screen Display ( , 42)					
No Information Display	○	–	○	○	○
Information Display	○	○	○	○	○

○ Available or set automatically. – Not available.

*1 FE lock not available in [, 3] flash mode.

Function	Shooting Mode								
									
AE Lock/FE Lock*1 ( 97, 120)	-	-	-	-	-	-	-	-	
AE Lock (Movie)/Exposure Shift ( 93)	-	-	-	-	-	-	-	○	
Tracking AF	-	-	-	○	○	○	○	-	
Screen Display ( 42)									
No Information Display	-	-	-	-	○	○	○	○	
Information Display	○	○	○	○	○	○	○	○	

○ Available or set automatically. – Not available.

*1 FE lock not available in [] flash mode.

FUNC. Menu



































Function	Shooting Mode					
	M	Av	Tv	P	LIVE	AUTO
Metering Method (📖98)						
	○	○	○	○	○	○
	○	○	○	○	–	–
My Colors (📖103)						
	○	○	○	○	○	○
*1 *1	○	○	○	○	–	–
*2	○	○	○	○	–	–
White Balance (📖101)						
	○	○	○	○	○	○
	○	○	○	○	–	–
Flash Exposure Compensation (📖119)						
	–	○	○	○	–	–
Flash Output Level (📖128)						
	○	○	○	–	–	–
Drive Mode (📖105)						
	○	○	○	○	○	○
	○	○	○	○	–	–
*3	○	○	○	○	–	–

○ Available or set automatically. – Not available.

*1 White balance is not available.

*2 Set in a range of 1 – 5: contrast, sharpness, color saturation, red, green, blue, and skin tone.

*3 [] is set with [MF], AF lock, or [].







































Function	Shooting Mode	SCN				
						
Metering Method ()						
		○	○	○	○	○
		–	–	–	–	–
My Colors ()						
		○	○	○	○	○
       		–	○	–	–	–
  		–	○	–	–	–
White Balance ()						
		○	○	○	○	○
     		–	○	○	–	–
Flash Exposure Compensation ()						
		–	–	–	–	–
Flash Output Level ()						
		–	–	–	–	–
Drive Mode ()						
		○	○	○	○	○
		○	–	○	○	○
 *3		–	–	○	○	○

○ Available or set automatically. – Not available.

*1 White balance is not available.

*2 Set in a range of 1 – 5: contrast, sharpness, color saturation, red, green, blue, and skin tone.

*3 [] is set with [], AF lock, or [].





Function	Shooting Mode							
								
Metering Method ( 98)								
	○	○	○	○	○	○	○	○
	-	-	-	-	-	-	-	-
My Colors ( 103)								
	○	○	○	○	○	○	○	○
       	-	-	-	-	-	-	○	○
  								
White Balance ( 101)								
	○	○	○	○	○	○	○	○
     	-	-	-	-	-	-	○	○
Flash Exposure Compensation ( 119)								
	-	-	-	-	-	-	-	-
Flash Output Level ( 128)								
	-	-	-	-	-	-	-	-
Drive Mode ( 105)								
	○	○	○	○	○	○	○	○
	○	○	○	○	○	○	○	-
 *3	○	○	○	○	○	○	○	-

○ Available or set automatically. – Not available.

*1 White balance is not available.

*2 Set in a range of 1 – 5: contrast, sharpness, color saturation, red, green, blue, and skin tone.

















*3 [] is set with [MF], AF lock, or [].

Function	Shooting Mode	M	Av	Tv	P	LIVE	AUTO
	Still Image Aspect Ratio (📖66)						
16:9		○	○	○	○	–	○
3:2		○	○	○	○	–	○
4:3		○	○	○	○	○	○
1:1		○	○	○	○	–	○
Resolution (📖67)							
L		○	○	○	○	○	○
M1 M2		○	○	○	○	–	○
M		–	–	–	–	–	–
S		○	○	○	○	–	○
Compression (📖121)							
		○	○	○	○	–	–
		○	○	○	○	○	○
Movie Quality (📖69)							
		○	○	○	○	○	○
		○	○	○	○	–	○

○ Available or set automatically. – Not available.

Function	Shooting Mode	SCN				
Still Image Aspect Ratio (📖66)						
16:9		○	○	–	○	○
3:2		○	○	–	○	○
4:3		○	○	○	○	○
1:1		○	○	–	○	○
Resolution (📖67)						
L		○	○	–	○	○
M1 M2		○	○	–	○	○
M		–	–	○	–	–
S		○	○	–	○	○
Compression (📖121)						
		–	–	–	–	–
		○	○	○	○	○
Movie Quality (📖69)						
		○	○	○	○	○
		○	○	○	○	○







○ Available or set automatically. – Not available.

Function	Shooting Mode							
								
Still Image Aspect Ratio ( 66)								
16:9	–	○	–	○	○	○	○	–
3:2	–	–	–	○	○	○	○	–
4:3	○	○	○	○	○	○	○	○
1:1	–	–	–	○	○	○	○	–
Resolution ( 67)								
L	○	○	○	○	○	○	○	○
M1 M2	–	–	–	–	–	–	○	○
M	–	–	–	–	–	–	–	–
S	–	–	–	–	–	–	○	○
Compression ( 121)								
	–	–	–	–	–	–	–	–
	○	○	○	○	○	○	○	○
Movie Quality ( 69)								
	○	*1	○	○	○	○	○	○
	○	*1	○	○	○	○	○	○

○ Available or set automatically. – Not available.

*1 Synchronizes with the aspect ratio setting and is automatically set ( 89).

Shooting Tab Menu













Function	Shooting Mode					
	M	Av	Tv	P	LIVE	AUTO
AF Frame ( 110)						
Center	○	○	○	○	○	–
Face AiAF* ₁	○	○	○	○	○	○
Tracking AF	○	○	○	○	○	–
AF Frame Size*₂ ( 111)						
Normal	○	○	○	○	○	–
Small	○	○	○	○	○	–
Digital Zoom ( 59)						
Standard	○	○	○	○	○	○
Off	○	○	○	○	○	○
1.6x/2.0x	○	○	○	○	○	–
AF-Point Zoom ( 72)						
On	○	○	○	○	○	○
Off	○	○	○	○	○	○
Servo AF ( 114)						
On	○	○	○	○	○	–
Off	○	○	○	○	○	* ₃
Continuous AF ( 115)						
On	○	○	○	○	○	○
Off	○	○	○	○	○	–
AF-assist Beam ( 74)						
On	○	○	○	○	○	○
Off	○	○	○	○	○	○

○ Available or set automatically. – Not available.

*₁ Operation when no faces are detected varies by shooting mode.

*₂ Available when the AF frame is set to [Center].

















*₃ [On] when subject movement is detected.

Function	SCN				
					
Shooting Mode					
AF Frame ( 110)					
Center	○	–	○	○	○
Face AiAF*1	○	○	○	○	–
Tracking AF	○	–	○	○	–
AF Frame Size*2 ( 111)					
Normal	○	–	○	○	–
Small	○	–	○	○	–
Digital Zoom ( 59)					
Standard	○	○	–	○	○
Off	○	○	○	○	○
1.6x/2.0x	–	–	–	–	–
AF-Point Zoom ( 72)					
On	○	○	○	○	–
Off	○	○	○	○	○
Servo AF ( 114)					
On	○	–	○	○	–
Off	○	○	○	○	○
Continuous AF ( 115)					
On	○	○	–	○	–
Off	○	–	○	○	○
AF-assist Beam ( 74)					
On	○	○	○	○	–
Off	○	○	○	○	○

○ Available or set automatically. – Not available.

*1 Operation when no faces are detected varies by shooting mode.

*2 Available when the AF frame is set to [Center].

Function	Shooting Mode								
									
AF Frame ( 110)									
Center	○	–	○	○	○	○	○	○	○
Face AiAF*1	–	–	○	○	○	○	○	○	○
Tracking AF	–	–	–	○	○	○	○	○	–
AF Frame Size*2 ( 111)									
Normal	○	–	○	○	○	○	○	○	○
Small	–	–	○	○	○	○	○	○	○
Digital Zoom ( 59)									
Standard	–	–	–	–	–	–	○	○	○
Off	○	○	○	○	○	○	○	○	○
1.6x/2.0x	–	–	–	–	–	–	–	–	–
AF-Point Zoom ( 72)									
On	–	–	–	○	○	○	○	○	–
Off	○	○	○	○	○	○	○	○	○
Servo AF ( 114)									
On	–	–	–	○	○	○	○	○	–
Off	○	○	○	○	○	○	○	○	○
Continuous AF ( 115)									
On	○	○	○	○	○	○	○	○	○
Off	○	○	○	○	○	○	○	○	–
AF-assist Beam ( 74)									
On	○	○	○	○	○	○	○	–	○
Off	○	○	○	○	○	○	○	○	○















○ Available or set automatically. – Not available.

*1 Operation when no faces are detected varies by shooting mode.

*2 Available when the AF frame is set to [Center].

Shooting Mode		M	Av	Tv	P	LIVE	AUTO
Function							
MF-Point Zoom (📖72)							
On		○	○	○	○	○	–
Off		○	○	○	○	○	○
Safety MF (📖108)							
On		○	○	○	○	○	–
Off		○	○	○	○	○	○
Flash Settings (📖68, 75, 119, 128)							
Flash Mode	Auto	–	○	○	○	○	○
	Manual	○	○	○	–	–	–
Flash Exp. Comp		–	○	○	○	–	–
Flash Output		○	○	○	–	–	–
Red-Eye Corr.	On	○	○	○	○	–	○
	Off	○	○	○	○	○	○
Red-Eye Lamp On/Off		○	○	○	○	○	○
Safety FE	On	–	○	○	○	○	○
	Off	○	○	○	○	○	–
i-Contrast (📖100)							
Auto		○	○	○	○	–	○
Off		○	○	○	○	○	–
Safety Shift (📖125)							
On		–	○	○	–	–	–
Off		○	○	○	○	○	○
Wind Filter (📖70)							
On/Off		○	○	○	○	○	○
Review image after shooting							
Display Time	Off/Quick/ 2 sec./4 sec./ 8 sec./Hold	○	○	○	○	○	○
Display Info	Off/Detailed	○	○	○	○	○	○

○ Available or set automatically. – Not available.





Shooting Mode		SCN				
						
Function						
MF-Point Zoom ( 72)						
On		O	–	O	O	–
Off		O	O	O	O	O
Safety MF ( 108)						
On		O	–	O	O	–
Off		O	O	O	O	O
Flash Settings ( 68,  75,  119,  128)						
Flash Mode	Auto	O	O	O	O	–
	Manual	–	–	–	–	–
Flash Exp. Comp		–	–	–	–	–
Flash Output		–	–	–	–	–
Red-Eye Corr.	On	O	O	O	O	–
	Off	O	O	O	O	–
Red-Eye Lamp	On/Off	O	O	O	O	–
Safety FE	On	O	O	O	O	–
	Off	–	–	–	–	–
i-Contrast ( 100)						
Auto		–	–	O	–	–
Off		O	O	–	O	O
Safety Shift ( 125)						
On		–	–	–	–	–
Off		O	O	O	O	O
Wind Filter ( 70)						
On/Off		O	O	O	O	O
Review image after shooting						
Display Time	Off/Quick/ 2 sec./4 sec./ 8 sec./Hold	O	O	O	O	O
Display Info	Off/Detailed	O	O	O	O	O

O Available or set automatically. – Not available.





















Shooting Mode										
Function										
MF-Point Zoom (📖72)										
On		-	-	-	○	○	○	○	-	
Off		○	○	○	○	○	○	○	○	
Safety MF (📖108)										
On		○	○	○	○	○	○	○	○	
Off		○	○	○	○	○	○	○	○	
Flash Settings (📖68, 75, 119, 128)										
Flash Mode	Auto	○	○	○	○	○	○	-	-	
	Manual	-	-	-	-	-	-	-	-	
Flash Exp. Comp		-	-	-	-	-	-	-	-	
Flash Output		-	-	-	-	-	-	-	-	
Red-Eye Corr.	On	-	-	-	-	-	-	-	-	
	Off	○	○	○	○	○	○	-	-	
Red-Eye Lamp On/Off		○	○	○	○	○	○	-	-	
Safety FE	On	○	○	○	○	○	○	-	-	
	Off	-	-	-	-	-	-	-	-	
i-Contrast (📖100)										
Auto		-	-	-	-	-	-	-	-	
Off		○	○	○	○	○	○	○	○	
Safety Shift (📖125)										
On		-	-	-	-	-	-	-	-	
Off		○	○	○	○	○	○	○	○	
Wind Filter (📖70)										
On/Off		○	-	○	○	○	○	○	○	
Review image after shooting										
Display Time	Off/Quick/ 2 sec./4 sec./ 8 sec./Hold	○	○	○	○	○	○	○	-	
	Display Info	○	○	○	○	○	○	○	-	

○ Available or set automatically. - Not available.

Shooting Mode	M	Av	Tv	P	LIVE	AUTO
Function						
Blink Detection (📖73)						
On	○	○	○	○	○	○
Off	○	○	○	○	○	○
Grid Lines (📖71)						
On/Off	○	○	○	○	○	○
IS Mode (📖57)						
Continuous/Off	○	○	○	○	○	○
Shoot Only	○	○	○	○	○	—
Date Stamp (📖64)						
Off	○	○	○	○	○	○
Date/Date & Time	○	○	○	○	○	○







Shooting Mode	SCN				
Function					
Blink Detection (📖73)					
On	○	○	○	○	—
Off	○	○	○	○	○
Grid Lines (📖71)					
On/Off	○	○	○	○	○
IS Mode (📖57)					
Continuous/Off	○	○	○	○	○
Shoot Only	○	○	○	○	○
Date Stamp (📖64)					
Off	○	○	○	○	○
Date/Date & Time	○	○	—	○	○





○ Available or set automatically. — Not available.

Shooting Mode	       							 	
	Function								
Blink Detection ( 73)									
On	–	–	–	–	○	○	○	○	–
Off	○	○	○	○	○	○	○	○	○
Grid Lines ( 71)									
On/Off	○	○	○	○	○	○	○	○	○
IS Mode ( 57)									
Continuous/Off	○	○	○	○	○	○	○	○	○
Shoot Only	○	○	○	○	○	○	○	○	–
Date Stamp ( 64)									
Off	○	○	○	○	○	○	○	○	○
Date/Date & Time	–	–	–	–	–	–	○	○	–









○ Available or set automatically. – Not available.







Set Up Tab Menu

Item	Ref. Page
Mute	 169
Volume	 169
Hints & Tips	 170
Date/Time	 26
Time Zone	 171
Lens Retract	 172
Eco Mode	 173
Power Saving	 39, 174
LCD Brightness	 175
Start-up Image	 175



Item	Ref. Page
Format	 176, 178
File Numbering	 179
Create Folder	 180
Units	 180
Video System	 190
Eye-Fi Settings	 216
Certification Logo Display	 181
Language 	 29
Reset All	 182



Playback Tab Menu

Item	Ref. Page
Slideshow	 139
Erase	 149
Protect	 143
Rotate	 153
Favorites	 155
Photobook Set-up	 213
i-Contrast	 162
Red-Eye Correction	 163





Item	Ref. Page
Cropping	 159
Resize	 157
My Colors	 161
Transition	 132
Scroll Display	 132
Auto Rotate	 154
Resume	 132





 Print Tab Menu

Item	Ref. Page
Print	–
Select Images & Qty.	 209
Select Range	 210

Item	Ref. Page
Select All Images	 211
Clear All Selections	 211
Print Settings	 207

Playback Mode FUNC. Menu

Item	Ref. Page
Rotate	 153
Protect	 143
Favorites	 155
Print	 199

Item	Ref. Page
Play Movie	 130
Smart Shuffle	 141
Image Search	 136
Slideshow	 139

Handling Precautions

- The camera is a high-precision electronic device. Avoid dropping it or subjecting it to strong impact.
- Never bring the camera near magnets, motors, or other devices that generate strong electromagnetic fields, which may cause malfunction or erase image data.
- If water droplets or dirt adheres to the camera or screen, wipe with a dry soft cloth, such as an eyeglass cloth. Do not rub hard or apply force.
- Never use cleaners containing organic solvents to clean the camera or screen.
- Use a blower brush to remove dust from the lens. If cleaning is difficult, contact a Canon Customer Support Help Desk.
- To prevent condensation from forming on the camera after sudden temperature changes (when the camera is transferred from cold to warm environments), put the camera in an airtight, resealable plastic bag and let it gradually adjust to the temperature before removing it from the bag.
- If condensation does form on the camera, stop using it immediately. Continuing to use the camera in this state may damage it. Remove the battery pack and memory card, and wait until the moisture has evaporated before resuming use.
- Before long-term battery storage, use up the battery pack's remaining charge, remove it from the camera, and store it in a plastic bag or similar container. Storing a partially charged battery pack over extended periods (about a year) may shorten its life or affect performance.

Specifications

Camera Effective Pixels (Max.)	Approx. 16 million pixels
Lens Focal Length	16x zoom: 5.0 (W) – 80.0 (T) mm (35mm film equivalent: 28 (W) – 448 (T) mm)
LCD Monitor	3.0-type color TFT LCD Effective Pixels: Approx. 230,000 dots
File Format	Design rule for Camera File system, DPOF (version 1.1) compliant
Data Type	Still Images: Exif 2.3 (JPEG) Movies: MOV (Video: H.264; Audio: Linear PCM (stereo))
Interface	Hi-speed USB Analog audio output (stereo) Analog video output (NTSC/PAL)
Power Source	Battery Pack NB-6LH AC Adapter Kit ACK-DC40
Dimensions (Based on CIPA Guidelines)	108.0 x 71.0 x 43.9 mm (4.25 x 2.79 x 1.73 in.)
Weight (Based on CIPA Guidelines)	Approx. 251 g (approx. 8.85 oz.; including the battery pack and memory card) Approx. 228 g (approx. 8.04 oz.; camera body only)

Number of Shots/Recording Time, Playback Time







Number of Shots	Approx. 300
Eco Mode On	Approx. 440
Movie Recording Time*¹	Approx. 1 hours, 20 minutes
Continuous Shooting*²	Approx. 2 hours, 20 minutes
Playback Time	Approx. 7 hours

*1 Time under default camera settings, when normal operations are performed, such as shooting, pausing, turning the camera on and off, and zooming.



*2 Time available when shooting the maximum movie length (until recording stops automatically) repeatedly.

- The number of shots that can be taken is based on measurement guidelines of the Camera & Imaging Products Association (CIPA).
- Under some shooting conditions, the number of shots and recording time may be less than mentioned above.
- Number of shots/time with a fully charged battery pack.

Number of 4:3 Shots per Memory Card



Recording Pixels	Compression Ratio	Number of Shots per Memory Card (Approx. shots)	
		8 GB	32 GB
L (Large) 16M/4608x3456		1131	4567
		1903	7684
M1 (Medium 1) 8M/3264x2448		2252	9094
		3721	15020
M2 (Medium 2) 2M/1600x1200		7442	30040
		12927	52176

S (Small) 0.3M/640x480		27291	110150
		40937	165225



- The values in the table are measured according to Canon standards and may change depending on the subject, memory card and camera settings.
- The values in the table are based on 4:3 aspect ratio. If the aspect ratio is changed ( 66), more images can be shot because the data size per image will be smaller than with 4:3 images. However, since  16:9 images have a setting of 1920 x 1080 pixels, their data size will be larger than 4:3 images.

Recording Time per Memory Card



Image Quality	Recording Time per Memory Card	
	8 GB	32 GB
	49 min. 15 sec.	3 hr. 19 min. 00 sec.
	1 hr. 28 min. 53 sec.	5 hr. 59 min. 05 sec.

- The values in the table are measured according to Canon standards and may change depending on the subject, memory card and camera settings.
- Recording will automatically stop when the clip file size reaches 4 GB, or when the recording time reaches approximately 29 minutes and 59 seconds when shooting in , or approximately 1 hour when shooting in .
- Recording may stop even if the maximum clip length has not been reached on some memory cards. SD Speed Class 4 or higher memory cards are recommended.

Flash Range





Maximum wide angle ()	50 cm – 3.0 m (1.6 – 9.8 ft.)
Maximum telephoto ()	60 cm – 2.0 m (2.0 – 6.6 ft.)

Shooting Range

Shooting Mode	Focusing Range	Maximum Wide Angle (☐☐☐)	Maximum Telephoto (☐☐☐)
AUTO	–	1 cm (0.4 in.) – infinity	60 cm (2.0 ft.) – infinity
Other modes		5 cm (2.0 in.) – infinity	60 cm (2.0 ft.) – infinity
		1 cm – 50 cm (0.4 in – 1.6 ft.)	–
	MF *	1 cm (0.4 in.) – infinity	60 cm (2.0 ft.) – infinity

* Not available in some shooting modes.

Continuous Shooting Speed

Shooting Mode	Continuous Shooting Mode	Speed
P		Approx. 0.8 shots/sec.
		Approx. 0.5 shots/sec.
		Approx. 0.6 shots/sec.
	–	Approx. 3.2 shots/sec.

■ Shutter Speed

[AUTO] mode, automatically set range	1 – 1/3200 sec.
[Tv] mode available values (sec.)	15, 13, 10, 8, 6, 5, 4, 3.2, 2.5, 2, 1.6, 1.3, 1, 0.8, 0.6, 0.5, 0.4, 0.3, 1/4, 1/5, 1/6, 1/8, 1/10, 1/13, 1/15, 1/20, 1/25, 1/30, 1/40, 1/50, 1/60, 1/80, 1/100, 1/125, 1/160, 1/200, 1/250, 1/320, 1/400, 1/500, 1/640, 1/800, 1/1000, 1/1250, 1/1600, 1/2000, 1/2500, 1/3200

■ Aperture

f/number	f/3.5 – f/8.0 (W), f/5.9 – f/8.0 (T)
[Av] mode available values*	f/3.5, f/4.0, f/4.5, f/5.0, f/5.6, f/5.9, f/6.3, f/7.1, f/8.0

* Depending on the zoom position, some aperture values may not be available.

Battery Pack NB-6LH

Type:	Rechargeable lithium-ion battery
Nominal Voltage:	3.7 V DC
Nominal Capacity:	1060 mAh
Charging Cycles:	Approx. 300 times
Operating Temperatures:	0 – 40 °C (32 – 104 °F)
Dimensions:	34.4 x 41.8 x 6.9 mm (1.35 x 1.65 x 0.27 in.)
Weight:	Approx. 22 g (approx. 0.78 oz.)

Battery Charger CB-2LY/CB-2LYE

Rated Input:	100 – 240 V AC (50/60 Hz), 0.085 A (100 V) – 0.05 A (240 V)
Rated Output:	4.2 V DC, 0.7 A
Charging Time:	Approx. 2 hr. (when using NB-6LH)
Charge Indicator:	Charging: orange / Fully charged: green (two-indicator system)
Operating Temperatures:	0 – 40 °C (32 – 104 °F)

Index

A

AC adapter kit.....	186, 191
Accessories	186
AE lock	97
AF frames	110
AF lock.....	116
Aspect ratio.....	66
AUTO mode (shooting mode).....	31, 41, 50
AV cable	189
Av (shooting mode)	125

B

Battery charger.....	2, 186
Battery pack	
Charging.....	21
Eco mode	173
Level.....	230
Power saving.....	39
Black and white images.....	103
Blink detection	73

C

Camera	
Reset all	182
Camera shake	122
Center (AF frame mode).....	110
Clock.....	48
Color (white balance).....	101

Compression ratio (image quality).....	121
Continuous shooting.....	105
Creative filters (shooting mode)...	84
Cropping.....	159, 202
Custom white balance	102

D

Date/time	
Adding date stamps	64
Changing	28
Date/time battery	29
Settings	26
World clock.....	171
DC coupler.....	191
Defaults → Reset all	
Digital tele-converter.....	109
Digital zoom.....	59
Discreet mode (shooting mode).....	91
Display language.....	29
DPOF.....	207
Drive mode	105

E

Eco mode	173
Editing	
Cropping.....	159
i-Contrast.....	162
My Colors	161
Red-eye correction.....	163

Resizing images	157
Erasing	149
Error messages	226
Exposure	
AE lock	97
Compensation	96
FE lock	120
Eye-Fi cards	3, 216

F

Face AiAF (AF frame mode).....	111
Face self-timer (shooting mode).....	82
Favorites.....	155
FE lock.....	120
File numbering.....	179
Fireworks (shooting mode).....	81
Fish-eye effect (shooting mode).....	86
Flash	
Flash exposure compensation.....	119
On	117
Focusing	
AF frames.....	110
AF lock	116
AF-point zoom.....	72
Servo AF	114
Focusing range	
Macro	107
Manual focus.....	108
Focus lock	111

FUNC. menu	
Basic operations.....	43
Table.....	239, 254

G

Grid lines	71
------------------	----

H

Household power.....	191
----------------------	-----

I

i-Contrast.....	100, 162
Image quality → Compression ratio (image quality)	
Images	
Display period	76
Erasing	149
Playback → Viewing Protecting	143
Indicator.....	47
ISO speed.....	99

L

Lamp.....	74, 75
Live View Control (shooting mode).....	79
Low light (shooting mode)	81

M

Macro (focus mode).....	107
Magnified display.....	138
Manual focus (focus mode)	108

Memory cards.....	3
Recording time	258
Menu	
Basic operations.....	45
Table.....	233
Metering method.....	98
Miniature effect (shooting mode).....	87
Monochrome (shooting mode).....	90
Movies	
Editing	165
Image quality (resolution/ frame rate).....	69
Recording time	258
M (shooting mode).....	126
My Colors	103, 161

P

Package contents	2
Photobook set-up	213
PictBridge	188, 199
Playback → Viewing	
Portrait (shooting mode).....	80
Poster effect (shooting mode)	85
Power	186
→ AC adapter kit	
→ Battery pack	
Power saving.....	39
Printing	199
Program AE	95
Protecting	143
P (shooting mode)	95

R

Red-eye correction	68, 163
Reset all.....	182
Resizing images	157
Resolution (image size).....	67
Rotating	153

S

Saving images to a computer....	196
Screen	
Display language.....	29
Icons.....	229, 231
Menu → FUNC. menu, Menu	
SD/SDHC/SDXC memory cards → Memory cards	
Searching	136
Self-timer	61
2-second self-timer.....	62
Customizing the self-timer.....	63
Face self-timer (shooting mode)	82
Sepia tone images.....	103
Servo AF.....	114
Shooting	
Shooting date/time → Date/time	
Shooting information	229
Slideshow	139
Smart Shuffle.....	141
Snow (shooting mode).....	81

Software	
Installation	194
Saving images to a computer	196
Sounds	169
Stereo AV cable	189
Strap	2, 20
Super vivid (shooting mode).....	85

T

Terminal.....	189, 199
Toy camera effect (shooting mode).....	89
Tracking AF	112
Traveling with the camera	171
Troubleshooting.....	220
TV display.....	189
Tv (shooting mode).....	124

V

Viewing	34
Image search	136
Index display	135
Magnified display	138
Single-image display	34
Slideshow.....	139
Smart Shuffle	141
TV display	189

W

White balance (color).....	101
Widescreen (resolution).....	67
World clock.....	171

Wrist strap → Strap

Z

Zoom	32, 51, 59
------------	------------

CAUTION

RISK OF EXPLOSION IF BATTERY IS REPLACED BY AN INCORRECT TYPE.
DISPOSE OF USED BATTERIES ACCORDING TO LOCAL REGULATION.

Battery Charger CB-2LY

**IMPORTANT SAFETY INSTRUCTIONS-
SAVE THESE INSTRUCTIONS.
DANGER-TO REDUCE THE RISK OF
FIRE OR ELECTRIC SHOCK, CAREFULLY
FOLLOW THESE INSTRUCTIONS.**

For connection to a supply not in the U.S.A., use an attachment plug adapter of the proper configuration for the power outlet, if needed.

**USA and Canada only:**

The Lithium ion/polymer battery that powers the product is recyclable.
Please call 1-800-8-BATTERY for information on how to recycle this battery.

FCC Notice

(Digital Camera, Model PC2006 systems)

This device complies with Part 15 of the FCC Rules. Operation is subject to the following two conditions;

- (1) this device may not cause harmful interference, and
- (2) this device must accept any interference received, including interference that may cause undesired operation.

Note: This equipment has been tested and found to comply with the limits for Class B digital devices, pursuant to Part 15 of the FCC rules. These limits are designed to provide reasonable protection against harmful interference in a residential installation.

This equipment generates, uses and can radiate radio frequency energy and, if not installed and used in accordance with the instructions, may cause harmful interference to radio communications. However, there is no guarantee that interference will not occur in a particular installation. If this equipment does cause harmful interference to radio or television reception, which can be determined by turning the equipment off and on, the user is encouraged to try to correct the interference by one or more of the following measures:

- Reorient or relocate the receiving antenna.
- Increase the separation between the equipment and receiver.
- Connect the equipment into an outlet on a circuit different from that to which the receiver is connected.
- Consult the dealer or an experienced radio/TV technician for help.

The cable with the ferrite core provided with the digital camera must be used with this equipment in order to comply with Class B limits in Subpart B of Part 15 of the FCC rules.

Do not make any changes or modifications to the equipment unless otherwise specified in the manual. If such changes or modifications should be made, you could be required to stop operation of the equipment.

Canon U.S.A., Inc.

One Canon Park, Melville, New York 11747, U.S.A.

Tel No. 1-800-OK-CANON (1-800-652-2666)

Canadian Radio Interference Regulations

CAN ICES-3 (B)/NMB-3 (B)

To ensure proper operation of this product, use of genuine Canon accessories is recommended.

For CA, USA only

Included lithium battery contains Perchlorate Material - special handling may apply.
See www.dtsc.ca.gov/hazardouswaste/perchlorate/ for details.

Trademarks and Licensing

- Microsoft and Windows are trademarks or registered trademarks of Microsoft Corporation in the United States and/or other countries.
- Macintosh and Mac OS are trademarks of Apple Inc., registered in the U.S. and other countries.
- The SDXC logo is a trademark of SD-3C, LLC.
- All other trademarks are the property of their respective owners.
- This device incorporates exFAT technology licensed from Microsoft.
- This product is licensed under AT&T patents for the MPEG-4 standard and may be used for encoding MPEG-4 compliant video and/or decoding MPEG-4 compliant video that was encoded only (1) for a personal and non-commercial purpose or (2) by a video provider licensed under the AT&T patents to provide MPEG-4 compliant video.
No license is granted or implied for any other use for MPEG-4 standard.

Disclaimer

- Reprinting, transmitting, or storing in a retrieval system any part of this guide without the permission of Canon is prohibited.
- Canon reserves the right to change the contents of this guide at any time without prior notice.
- Illustrations and screenshots in this guide may differ slightly from the actual equipment.
- The above items notwithstanding, Canon accepts no liability for damages due to mistaken operation of the products.